

**P5WDG2 WS
Professional**



Motherboard

E2769

Second Edition V2
August 2006

Copyright © 2006 ASUSTeK COMPUTER INC. All Rights Reserved.

No part of this manual, including the products and software described in it, may be reproduced, transmitted, transcribed, stored in a retrieval system, or translated into any language in any form or by any means, except documentation kept by the purchaser for backup purposes, without the express written permission of ASUSTeK COMPUTER INC. (“ASUS”).

Product warranty or service will not be extended if: (1) the product is repaired, modified or altered, unless such repair, modification or alteration is authorized in writing by ASUS; or (2) the serial number of the product is defaced or missing.

ASUS PROVIDES THIS MANUAL “AS IS” WITHOUT WARRANTY OF ANY KIND, EITHER EXPRESS OR IMPLIED, INCLUDING BUT NOT LIMITED TO THE IMPLIED WARRANTIES OR CONDITIONS OF MERCHANTABILITY OR FITNESS FOR A PARTICULAR PURPOSE. IN NO EVENT SHALL ASUS, ITS DIRECTORS, OFFICERS, EMPLOYEES OR AGENTS BE LIABLE FOR ANY INDIRECT, SPECIAL, INCIDENTAL, OR CONSEQUENTIAL DAMAGES (INCLUDING DAMAGES FOR LOSS OF PROFITS, LOSS OF BUSINESS, LOSS OF USE OR DATA, INTERRUPTION OF BUSINESS AND THE LIKE), EVEN IF ASUS HAS BEEN ADVISED OF THE POSSIBILITY OF SUCH DAMAGES ARISING FROM ANY DEFECT OR ERROR IN THIS MANUAL OR PRODUCT.

SPECIFICATIONS AND INFORMATION CONTAINED IN THIS MANUAL ARE FURNISHED FOR INFORMATIONAL USE ONLY, AND ARE SUBJECT TO CHANGE AT ANY TIME WITHOUT NOTICE, AND SHOULD NOT BE CONSTRUED AS A COMMITMENT BY ASUS. ASUS ASSUMES NO RESPONSIBILITY OR LIABILITY FOR ANY ERRORS OR INACCURACIES THAT MAY APPEAR IN THIS MANUAL, INCLUDING THE PRODUCTS AND SOFTWARE DESCRIBED IN IT.

Products and corporate names appearing in this manual may or may not be registered trademarks or copyrights of their respective companies, and are used only for identification or explanation and to the owners’ benefit, without intent to infringe.

Contents

Notices	vii
Safety information	viii
About this guide	ix
P5WDG2 WS Professional specifications summary	xi

Chapter 1: Product introduction

1.1	Welcome!	1-1
1.2	Package contents	1-1
1.3	Special features	1-2
1.3.1	Product highlights	1-2
1.3.2	ASUS Intelligence (AI) features	1-5
1.3.3	Innovative ASUS features	1-6

Chapter 2: Hardware information

2.1	Before you proceed	2-1
2.2	Motherboard overview	2-2
2.2.1	Placement direction	2-2
2.2.2	Screw holes	2-2
2.2.3	ASUS Stack Cool 2	2-3
2.2.4	Motherboard layout	2-4
2.2.5	Layout contents	2-5
2.3	Central Processing Unit (CPU)	2-7
2.3.1	Installing the CPU	2-8
2.3.2	Installing the CPU heatsink and fan	2-10
2.3.3	Uninstalling the CPU heatsink and fan	2-12
2.4	System memory	2-14
2.4.1	Overview	2-14
2.4.2	Memory configurations	2-14
2.4.3	Installing a DIMM	2-19
2.4.4	Removing a DIMM	2-19
2.5	Expansion slots	2-20
2.5.1	Installing an expansion card	2-20
2.5.2	Configuring an expansion card	2-20
2.5.3	Interrupt assignments	2-21
2.5.4	PCI Express x16 slots	2-22
2.5.5	PCI slots	2-22
2.5.6	PCI-X slots	2-22
2.6	Jumpers	2-27
2.7	Connectors	2-29
2.7.1	Rear panel connectors	2-29
2.7.2	Internal connectors	2-32

Contents

Chapter 3: Powering up

- 3.1 Starting up for the first time 3-1
- 3.2 Turning off the computer 3-2
 - 3.2.1 Using the OS shut down function 3-2
 - 3.2.2 Using the dual function power switch 3-2

Chapter 4: BIOS setup

- 4.1 Managing and updating your BIOS 4-1
 - 4.1.1 ASUS Update utility 4-1
 - 4.1.2 Creating a bootable floppy disk 4-4
 - 4.1.3 ASUS EZ Flash 2 utility 4-5
 - 4.1.4 AFUDOS utility 4-6
 - 4.1.5 ASUS CrashFree BIOS 3 utility 4-9
- 4.2 BIOS setup program 4-11
 - 4.2.1 BIOS menu screen 4-12
 - 4.2.2 Menu bar 4-12
 - 4.2.3 Navigation keys 4-12
 - 4.2.4 Menu items 4-13
 - 4.2.5 Sub-menu items 4-13
 - 4.2.6 Configuration fields 4-13
 - 4.2.7 Pop-up window 4-13
 - 4.2.8 Scroll bar 4-13
 - 4.2.9 General help 4-13
- 4.3 Main menu 4-14
 - 4.3.1 System Time 4-14
 - 4.3.2 System Date 4-14
 - 4.3.3 Legacy Diskette A 4-14
 - 4.3.4 Language 4-14
 - 4.3.5 Primary, Third, and Fourth IDE Master/Slave 4-15
 - 4.3.6 IDE Configuration 4-16
 - 4.3.7 System Information 4-18
- 4.4 Advanced menu 4-19
 - 4.4.1 JumperFree Configuration 4-19
 - 4.4.2 LAN Cable Status 4-23
 - 4.4.3 USB Configuration 4-24
 - 4.4.4 CPU Configuration 4-26
 - 4.4.5 Chipset 4-28
 - 4.4.6 Onboard Devices Configuration 4-30
 - 4.4.7 PCI PnP 4-32

Contents

4.5	Power menu	4-32
4.5.1	Suspend Mode	4-33
4.5.2	Repost Video on S3 Resume	4-33
4.5.3	ACPI 2.0 Support	4-33
4.5.4	ACPI APIC Support	4-34
4.5.5	APM Configuration	4-34
4.5.6	Hardware Monitor	4-36
4.6	Boot menu	4-37
4.6.1	Boot Device Priority	4-38
4.6.2	Removable Drives	4-39
4.6.3	Boot Settings Configuration	4-39
4.6.4	Security	4-41
4.7	Tools	4-44
4.7.1	EZ Flash 2	4-44
4.7.2	ASUS O.C. Profile	4-45
4.8	Exit menu	4-47

Chapter 5: Software support

5.1	Installing an operating system	5-1
5.2	Support CD information	5-1
5.2.1	Running the support CD	5-1
5.2.2	Drivers menu	5-2
5.2.3	Utilities menu	5-3
5.2.4	Make Disk menu	5-5
5.2.5	Manuals menu	5-6
5.2.6	Contact information	5-6
5.2.7	Other information	5-7
5.3	Software information	5-11
5.3.1	ASUS MyLogo2™	5-11
5.3.2	AI NET2	5-13
5.3.3	AI Gear	5-14
5.3.4	AI Nap	5-16
5.3.5	AI Booster	5-17
5.3.6	ASUS PC Probe II	5-18
5.3.7	SoundMAX® High Definition Audio utility	5-24
5.4	RAID configurations	5-29
5.4.1	Installing Serial ATA hard disks	5-30
5.4.2	Intel® RAID configurations	5-30
5.5	Creating a RAID driver disk	5-41

Appendix: CPU features

A.1	Intel® EM64T	A-1
A.2	Enhanced Intel SpeedStep® Technology (EIST)	A-1
A.3	Intel® Hyper-Threading Technology	A-3

Notices

Federal Communications Commission Statement

This device complies with Part 15 of the FCC Rules. Operation is subject to the following two conditions:

- This device may not cause harmful interference, and
- This device must accept any interference received including interference that may cause undesired operation.

This equipment has been tested and found to comply with the limits for a Class B digital device, pursuant to Part 15 of the FCC Rules. These limits are designed to provide reasonable protection against harmful interference in a residential installation. This equipment generates, uses and can radiate radio frequency energy and, if not installed and used in accordance with manufacturer's instructions, may cause harmful interference to radio communications. However, there is no guarantee that interference will not occur in a particular installation. If this equipment does cause harmful interference to radio or television reception, which can be determined by turning the equipment off and on, the user is encouraged to try to correct the interference by one or more of the following measures:

- Reorient or relocate the receiving antenna.
- Increase the separation between the equipment and receiver.
- Connect the equipment to an outlet on a circuit different from that to which the receiver is connected.
- Consult the dealer or an experienced radio/TV technician for help.



The use of shielded cables for connection of the monitor to the graphics card is required to assure compliance with FCC regulations. Changes or modifications to this unit not expressly approved by the party responsible for compliance could void the user's authority to operate this equipment.

Canadian Department of Communications Statement

This digital apparatus does not exceed the Class B limits for radio noise emissions from digital apparatus set out in the Radio Interference Regulations of the Canadian Department of Communications.

This class B digital apparatus complies with Canadian ICES-003.

Safety information

Electrical safety

- To prevent electrical shock hazard, disconnect the power cable from the electrical outlet before relocating the system.
- When adding or removing devices to or from the system, ensure that the power cables for the devices are unplugged before the signal cables are connected. If possible, disconnect all power cables from the existing system before you add a device.
- Before connecting or removing signal cables from the motherboard, ensure that all power cables are unplugged.
- Seek professional assistance before using an adapter or extension cord. These devices could interrupt the grounding circuit.
- Make sure that your power supply is set to the correct voltage in your area. If you are not sure about the voltage of the electrical outlet you are using, contact your local power company.
- If the power supply is broken, do not try to fix it by yourself. Contact a qualified service technician or your retailer.

Operation safety

- Before installing the motherboard and adding devices on it, carefully read all the manuals that came with the package.
- Before using the product, make sure all cables are correctly connected and the power cables are not damaged. If you detect any damage, contact your dealer immediately.
- To avoid short circuits, keep paper clips, screws, and staples away from connectors, slots, sockets and circuitry.
- Avoid dust, humidity, and temperature extremes. Do not place the product in any area where it may become wet.
- Place the product on a stable surface.
- If you encounter technical problems with the product, contact a qualified service technician or your retailer.



The symbol of the crossed out wheeled bin indicates that the product (electrical and electronic equipment) should not be placed in municipal waste. Please check local regulations for disposal of electronic products.

About this guide

This user guide contains the information you need when installing and configuring the motherboard.

How this guide is organized

This user guide contains the following parts:

- **Chapter 1: Product introduction**
This chapter describes the features of the motherboard and the new technology it supports.
- **Chapter 2: Hardware information**
This chapter lists the hardware setup procedures that you have to perform when installing system components. It includes description of the switches, jumpers, and connectors on the motherboard.
- **Chapter 3: Powering up**
This chapter describes the power up sequence and ways of shutting down the system.
- **Chapter 4: BIOS setup**
This chapter tells how to change system settings through the BIOS Setup menus. Detailed descriptions of the BIOS parameters are also provided.
- **Chapter 5: Software support**
This chapter describes the contents of the support CD that comes with the motherboard package.
- **Appendix: CPU features**
The Appendix describes the CPU features and technologies that the motherboard supports.

Where to find more information

Refer to the following sources for additional information and for product and software updates.

1. ASUS websites

The ASUS website provides updated information on ASUS hardware and software products. Refer to the ASUS contact information.

2. Optional documentation

Your product package may include optional documentation, such as warranty flyers, that may have been added by your dealer. These documents are not part of the standard package.

Conventions used in this guide

To make sure that you perform certain tasks properly, take note of the following symbols used throughout this manual.



DANGER/WARNING: Information to prevent injury to yourself when trying to complete a task.



CAUTION: Information to prevent damage to the components when trying to complete a task.



IMPORTANT: Instructions that you **MUST** follow to complete a task.



NOTE: Tips and additional information to help you complete a task.

Typography

Bold text

Indicates a menu or an item to select.

Italics

Used to emphasize a word or a phrase.

<Key>

Keys enclosed in the less-than and greater-than sign means that you must press the enclosed key.

Example: <Enter> means that you must press the Enter or Return key.

<Key1+Key2+Key3>

If you must press two or more keys simultaneously, the key names are linked with a plus sign (+).

Example: <Ctrl+Alt+D>

Command

Means that you must type the command exactly as shown, then supply the required item or value enclosed in brackets.

Example: At the DOS prompt, type the command line:

```
afudos /i[filename]  
afudos /iWDG2WSP.ROM
```

P5WDG2 WS Professional specifications summary

CPU	LGA775 socket for Intel® Core™2 Duo/Pentium® D/ Pentium® 4/Celeron® CPU support Intel® Presler 65nm Dual core CPU support Intel® next generation Core™2 Duo CPU support Compatible with Intel® 06B, 05B/05A and 04B/04A processors Supports Intel EIST/EM64T/Hyper-Threading Technology
Chipset	Northbridge: Intel® 975X Express Memory Controller Hub (MCH) Southbridge: Intel® ICH7R PCI-X Bridge: Intel® 6702PXH (PXH-V)
Front Side Bus	1066/800/533 MHz
Memory	Dual-channel memory architecture 4 x 240-pin DIMM sockets support up to 8 GB system memory unbuffered ECC/non-ECC DDR2 667/ 533 MHz memory modules Native DDR2 800 support
Expansion slots	2 x PCI Express™ x16 slots for discrete graphics cards 2 x PCI-X® slots 2 x PCI 2.2 slots
CrossFire™	Supports ATI CrossFire™ graphics cards
Storage	Intel® ICH7R Southbridge supports: - 1 x IDE connector for up to two Ultra DMA 100/66/33 hard disks - 4 x Serial ATA I/II 3.0 Gb/s hard disks with RAID 0, RAID 1, RAID 10, and RAID 5 configuration - Intel® Matrix Storage Technology Marvell® 88SE614x Serial ATA controller supports: - 4 x Serial ATA I/II 3.0 Gb/s hard disks
LAN	Marvell® 88E8052+88E8001 Dual Gigabit LAN controllers - Support teaming function
High Definition Audio	High definition audio, ADI® AD1988B SoundMax 7.1 channel CODEC Supports Multi-streaming, Jack-sensing, and Jack-retasking functions Coaxial and optical S/PDIF out ports

(continued on the next page)

P5WDG2 WS Professional specifications summary

IEEE 1394a	T1 1394a controller supports: - 2 x IEEE 1394a ports
USB	Supports up to 8 USB 2.0 ports
ASUS special features - Performance	<p>Intelligent overclocking tools:</p> <ul style="list-style-type: none"> - AI NOS™ (Non-delay Overclocking System) - AI Overclocking (intelligent CPU frequency tuner) - AI Clock Skew - ASUS PEG Link (automatic performance tuning for single/dual graphics cards) - ASUS BIOS Profile - ASUS C.P.R. (CPU Parameter Recall) - ASUS AI Booster - Adjustable FSB/DDR2 ratio. Fixed PCI/PCIe frequencies. - Hyper Path 3 <p>Precision Tweaker:</p> <ul style="list-style-type: none"> - vDIMM: 12-step DRAM voltage control - vCore: Adjustable CPU voltage at 0.0125 V increment - Stepless Frequency Selection(SFS): allowing FSB tuning from 100 MHz up to 550 MHz at 1 MHz increment - PCI Express x16 frequency: allowing PCI Express x16 frequency tuning from 90 MHz to 150 MHz at 1 MHz increment
ASUS special features - Thermal	ASUS 8-Phase Power Design Stack Cool 2 Q-Fan 2 ASUS Heat-pipe thermal solution
ASUS special features - Life	Multi-language BIOS SATA on the Go AI Nap AI Gear My Logo 2
ASUS special features - Others	CrashFree BIOS 3 EZ Flash 2 ASUS AI NET 2 Q-Connector ASUS AI Quiet
BIOS features	8 Mb Flash ROM, AMI BIOS, Green PnP, DMI2.0, WfM2.0, ACPI 2.0a, SM BIOS 2.3

(continued on the next page)

P5WDG2 WS Professional specifications summary

Rear panel	<ul style="list-style-type: none"> 1 x PS/2 mouse port 1 x PS/2 keyboard port 1 x Parallel port 2 x LAN (RJ-45) ports 1 x Coaxial S/PDIF Out port 1 x Optical S/PDIF Out port 1 x eSATA port 4 x USB 2.0 ports 8-Channel audio ports
Internal connectors	<ul style="list-style-type: none"> 1 x Floppy disk drive connector 1 x Primary IDE connector 4 x ICH7R Serial ATA connectors 4 x Marvell® 88SE61x Serial ATA RAID connectors 1 x Optical drive audio connector 1 x Front panel audio connector 2 x USB connectors for four additional USB 2.0 ports 2 x IEEE 1394a port connector 1 x Chassis intrusion connector 1 x CPU fan connector 2 x Chassis fan connectors 1 x Power fan connector 1 x Serial port (COM1) connector EATX power connectors (24-pin and 2 x 4-pin) System panel connector
Support CD contents	<ul style="list-style-type: none"> Device drivers BIOS Flash Utility under DOS ASUS AI Booster ASUS Update ASUS PC Probe 2 Anti virus software Microsoft® DirectX 9.0c Adobe® Acrobat Reader® RAID Utility
Manageability	<ul style="list-style-type: none"> WOL by PME, WOR by PME, chassis intrusion, PXE, AI NET2
Power Requirement	<ul style="list-style-type: none"> ATX power supply (with 24-pin and 2 x 4-pin 12 V plugs) ATX 12V 2.0 or later standard compliant
Form Factor	<ul style="list-style-type: none"> ATX form factor: 12 in x 9.6 in (30.5 cm x 24.5 cm)

*Specifications are subject to change without notice.

This chapter describes the motherboard features and the new technologies it supports.

Product introduction



Chapter summary



1.1	Welcome!	1-1
1.2	Package contents	1-1
1.3	Special features	1-2

1.1 Welcome!

Thank you for buying an ASUS® P5WDG2 WS Professional Workstation motherboard!

The motherboard delivers a host of new features and latest technologies, making it another standout in the long line of ASUS quality motherboards!

Before you start installing the motherboard, and hardware devices on it, check the items in your package with the list below.

1.2 Package contents

Check your motherboard package for the following items.

Motherboard	ASUS P5WDG2 WS Professional motherboard
I/O modules	1 x IEEE 1394a module 1 x USB 2.0 module 1 x COM1 module
Cables	1 x 2-in-1 FDD/ATA/Logo+Pull cable 7 x Serial ATA signal cables 4 x Serial ATA power cables for up to 7 devices
Accessories	I/O shield
Application CD	ASUS motherboard support CD
Documentation	User guide



If any of the above items is damaged or missing, contact your retailer.

1.3 Special features

1.3.1 Product highlights

Latest processor technology

The motherboard comes with a 775-pin surface mount Land Grid Array (LGA) socket designed for the Intel® Pentium® 4/Celeron®/Pentium® D/Pentium® Processor Extreme Edition in the 775-land package with 1066/800/533 MHz Front Side Bus (FSB). The motherboard also supports the Intel® Hyper-Threading Technology and is fully compatible with Intel® 05B/05A and 04B/04A processors. See page 2-7 for details.

Intel® 65nm Dual-Core CPU support



This motherboard supports Intel® Pentium® D/Pentium® 4/Celeron® dual-core processors built on the 65-nanometer (nm) process technology with copper interconnect. Dual-core processors contain two physical CPU cores with dedicated L2 caches to meet demands for more powerful processing. Intel®'s 65nm process is the most advanced chip manufacturing technology, delivering breakthrough performance, enhanced media experience, and low power consumption. Intel® 65nm dual-core processors utilize the latest package technologies for a thinner, lighter design without compromising performance. This motherboard also supports Intel® next generation Core™2 Duo CPU. This motherboard supports the latest Intel® Core™2 processors in LGA775 package. With new Intel® Core™ microarchitecture technology and 1066/800 MHz FSB, Intel® Core™2 processor is one of the most powerful and energy-efficient CPUs in the world.

Intel® 975X Express/ICH7R chipset

The Intel® 975X Express Memory Controller Hub (MCH) and the ICH7R I/O controller hub provide the vital interfaces for the motherboard. The Intel® 975X Express is the latest chipset designed to support Dual PCI Express graphics, along with the maximum 8 GB dual-channel DDR2 800/667/533 MHz, 1066/800/533 FSB, and dual-core CPU. The MCH also supports the Intel® Memory Pipeline Technology (MPT) that boosts system performance.

The Intel® ICH7R Southbridge integrates four Serial ATA I/II connectors enabled through the Serial ATA 3 Gb/s RAID controller to ensure data security and enable powerful multi-task processing.

Intel® Memory Pipeline Technology (MPT)

The Intel® MPT increases system-level and standard operating performance by optimizing memory access between CPU and system memory.

Intel® EM64T

The motherboard supports Intel® Pentium® 4 CPUs with the Intel® EM64T (Extended Memory 64 Technology). The Intel® EM64T feature allows your computer to run on 64-bit operating systems and access larger amounts of system memory for faster and more efficient computing. See the Appendix for details.

Enhanced Intel SpeedStep® Technology (EIST)

The Enhanced Intel SpeedStep® Technology (EIST) intelligently manages the CPU resources by automatically adjusting the CPU voltage and core frequency depending on the CPU loading and system speed or power requirement. See page 4-26 and the Appendix for details.

DDR2 memory support

The motherboard supports DDR2 memory, which features data transfer rates of 800/667/533 MHz to meet the higher bandwidth requirements of the latest 3D graphics, multimedia, and Internet applications. The dual-channel DDR2 architecture doubles the bandwidth of your system memory to boost system performance, eliminating bottlenecks with peak bandwidths of up to 10.7 GB/s. See page 2-14 for details.

Serial ATA I/II technology

The motherboard supports the Serial ATA 3 Gb/s technology through the Serial ATA interfaces and the Intel® 975X Express MCH chipset. The Serial ATA 3 Gb/s specification provides twice the bandwidth of the current Serial ATA products with a host of new features, including Native Command Queuing (NCQ), Power Management (PM) Implementation Algorithm, and Hot Swap. Serial ATA allows thinner, more flexible cables with lower pin count and reduced voltage requirements. See pages 2-35 and 2-36 for details.

PCI-X® interface

The motherboard supports PCI-X, the new and improved version of the previous PCI standard. PCI-X offers faster data transfers and enhanced system reliability with ECC automatic single-bit error recovery and double-bit error detection. PCI-X, which is backward-compatible with PCI-based hardware and software, enables users to keep pace with upcoming advances in high-bandwidth, business-critical applications such as Fiber Channel, RAID, InfiniBrand™ Architecture, and iSCSI. See page 2-23 for details.

PCI Express™ interface

The motherboard fully supports PCI Express, the latest I/O interconnect technology that speeds up the PCI bus. PCI Express features point-to-point serial interconnections between devices and allows higher clockspeeds by carrying data in packets. This high speed interface is software compatible with existing PCI specifications. See page 2-23 for details.

S/PDIF digital sound ready

The motherboard supports the S/PDIF technology through the S/PDIF interfaces on the rear panel. The S/PDIF technology turns your computer into a high-end entertainment system with digital connectivity to powerful audio and speaker systems. See page 2-33 for details.

8-channel high definition audio

Onboard is the ADI AD1988B High Definition Audio 8-channel audio CODEC. This CODEC is fully-compliant with Intel® High Definition Audio standard (192 KHz, 24-bit audio). With the CODEC, 8-channel audio ports, and S/PDIF interfaces, you can connect your computer to home theater decoders to produce crystal-clear digital audio.

IEEE 1394a support

The motherboard supports the IEEE 1394a interface that provides high-speed and flexible PC connectivity to a wide range of peripherals and devices compliant to IEEE 1394a standards. The IEEE 1394a interface allows up to 400 Mbps transfer rates through simple, low-cost, high-bandwidth asynchronous (real-time) data interfacing between computers, peripherals, and consumer electronic devices such as camcorders, VCRs, printers, TVs, and digital cameras. See pages 2-33 and 2-38 for details.

USB 2.0 technology

The motherboard implements the Universal Serial Bus (USB) 2.0 specification, dramatically increasing the connection speed from the 12 Mbps bandwidth on USB 1.1 to a fast 480 Mbps on USB 2.0. USB 2.0 is backward compatible with USB 1.1. See pages 2-33 and 2-38 for details.

Dual Gigabit LAN solution

The motherboard comes with dual Gigabit LAN controllers to provide the total solution for your networking needs. These network controllers use the PCI Express segment to provide faster data bandwidth for your wired or wireless Internet, LAN, and file sharing requirements. See page 2-32 for details.

Trusted Platform Module (TPM) *[optional]*

The Trusted Platform Module (TPM) is a secure microcontroller hardware component with embedded software. The motherboard implements the optional module to provide the first link in the chain of trust, providing convenient single sign-on to systems and enable digital signatures for secure transactions. See page 2-43 for details.

1.3.2 ASUS Intelligence (AI) features

ASUS Stack Cool 2

ASUS Stack Cool 2 is a fan-less and zero-noise cooling solution that lowers the temperature of critical heat generating components by 20°C. The motherboard uses a special design on the printed circuit board (PCB) to dissipate heat that critical components generate. See page 2-3 for details.

AI Quiet

The ASUS AI Quiet function dynamically controls CPU speed and reduces temperature and fan speeds, thus minimizing noise and ensuring quiet operation. See page 4-35 for details.

1.3.3 Innovative ASUS features

Native DDR2-800 memory support



Native DDR2-800 eliminates the bottleneck when overclocking both the CPU and the memory, thus maximizing performance for 3D graphics and other system-intensive applications. See pages 2-16 and 4-20 for details.

AI Overclocking

This feature allows convenient overclocking up to 30 percent (depending on the installed CPU and DRAM) to enhance system performance while still maintaining system stability. See page 4-19 to set the BIOS items for overclocking.

AI NET2

AI NET2 is a BIOS-based diagnostic tool that detects and reports Ethernet cable faults and shorts. With this utility, you can easily monitor the condition of the Ethernet cable connected to the LAN (RJ-45) port. During the bootup process, AI NET2 immediately diagnoses the LAN cable and reports shorts and faults up to 100 meters at 1 meter accuracy. See pages 4-23 and 5-13 for details.

PEG Link Mode

This feature enhances your PCI Express graphics card performance by allowing the motherboard to automatically adjust the PCI Express graphics link mode to the correct frequency based on the system configuration. Four additional settings are available for overclocking the PEG Link Mode. See page 4-28 for details.

CPU Lock Free

This feature allows you to adjust the CPU multiplier to 14x. Setting the appropriate BIOS setting automatically reduces the CPU multiplier value for more flexibility when increasing external FSB. See page 4-20 for details.

ASUS Q-Fan 2 technology

The ASUS Q-Fan 2 technology smartly adjusts the fan speeds according to the system loading to ensure quiet, cool, and efficient operation. See page 4-35 for details.

ASUS Multi-language BIOS

The multi-language BIOS allows you to select the language of your choice from the available options. The localized BIOS menus allow easier and faster configuration. See page 4-14 for details.

ASUS MyLogo2™

This new feature present in the motherboard allows you to personalize and add style to your system with customizable boot logos. See pages 4-38 and 5-11 for details.

ASUS CrashFree BIOS 3

This feature allows you to restore the original BIOS data from the support CD in case when the BIOS codes and data are corrupted. This protection eliminates the need to buy a replacement ROM chip. See page 4-9 for details.

ASUS EZ Flash 2 BIOS

With the ASUS EZ Flash 2, you can easily update the system BIOS even before loading the operating system. No need to use a DOS-based utility or boot from a floppy disk. See page 4-5 for details.

This chapter lists the hardware setup procedures that you have to perform when installing system components. It includes description of the jumpers and connectors on the motherboard.

Hardware information



Chapter summary



2.1	Before you proceed	2-1
2.2	Motherboard overview	2-2
2.3	Central Processing Unit (CPU)	2-7
2.4	System memory	2-14
2.5	Expansion slots	2-21
2.6	Jumpers	2-28
2.7	Connectors	2-30

2.1 Before you proceed

Take note of the following precautions before you install motherboard components or change any motherboard settings.



- Unplug the power cord from the wall socket before touching any component.
- Use a grounded wrist strap or touch a safely grounded object or a metal object, such as the power supply case, before handling components to avoid damaging them due to static electricity.
- Hold components by the edges to avoid touching the ICs on them.
- Whenever you uninstall any component, place it on a grounded antistatic pad or in the bag that came with the component.
- **Before you install or remove any component, ensure that the ATX power supply is switched off or the power cord is detached from the power supply.** Failure to do so may cause severe damage to the motherboard, peripherals, and/or components.

Onboard LED

The motherboard comes with a standby power LED. The green LED lights up to indicate that the system is ON, in sleep mode, or in soft-off mode. This is a reminder that you should shut down the system and unplug the power cable before removing or plugging in any motherboard component. The illustration below shows the location of the onboard LED.

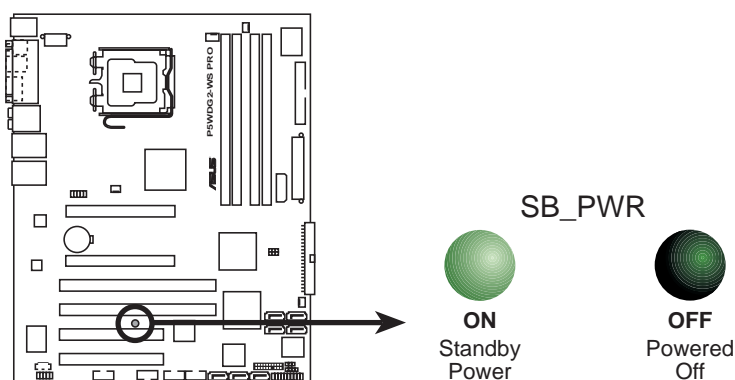

P5WDG2-WS PRO Onboard LED

2.2 Motherboard overview

Before you install the motherboard, study the configuration of your chassis to ensure that the motherboard fits into it.



Make sure to unplug the power cord before installing or removing the motherboard. Failure to do so can cause you physical injury and damage motherboard components.

2.2.1 Placement direction

When installing the motherboard, make sure that you place it into the chassis in the correct orientation. The edge with external ports goes to the rear part of the chassis as indicated in the image below.

2.2.2 Screw holes

Place nine (9) screws into the holes indicated by circles to secure the motherboard to the chassis.



Do not overtighten the screws! Doing so can damage the motherboard.

Place this side towards the rear of the chassis

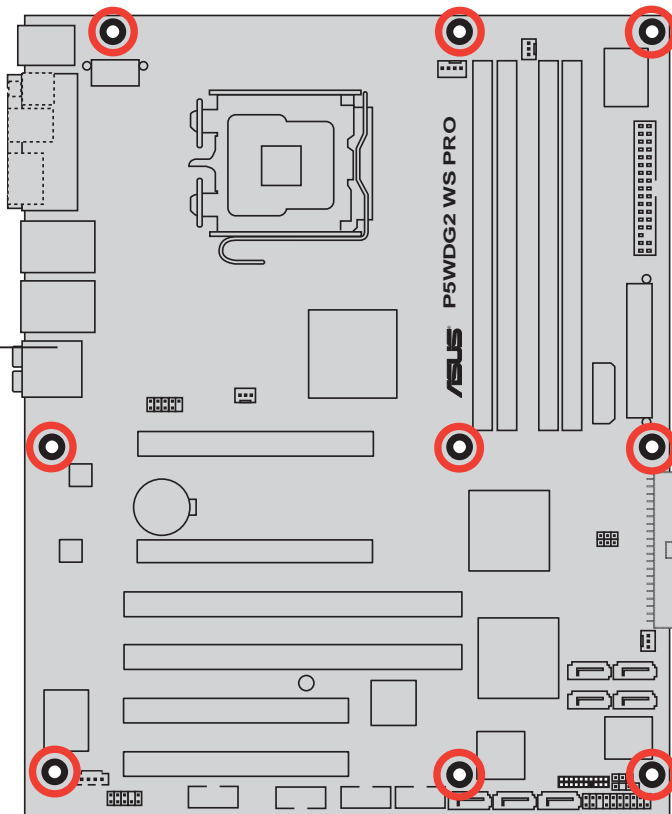

2.2.3 ASUS Stack Cool 2

The motherboard comes with the ASUS Stack Cool 2 cooling solution that lowers the temperature of critical heat generating components by 20°C. The motherboard uses a special design on the printed circuit board (PCB) to dissipate heat that critical components generate.

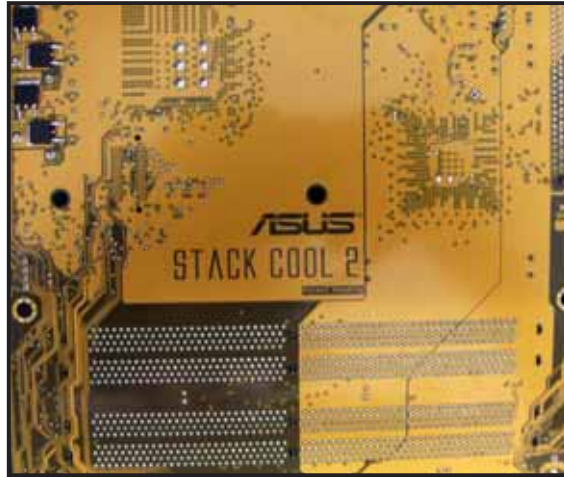

2.2.4 Motherboard layout

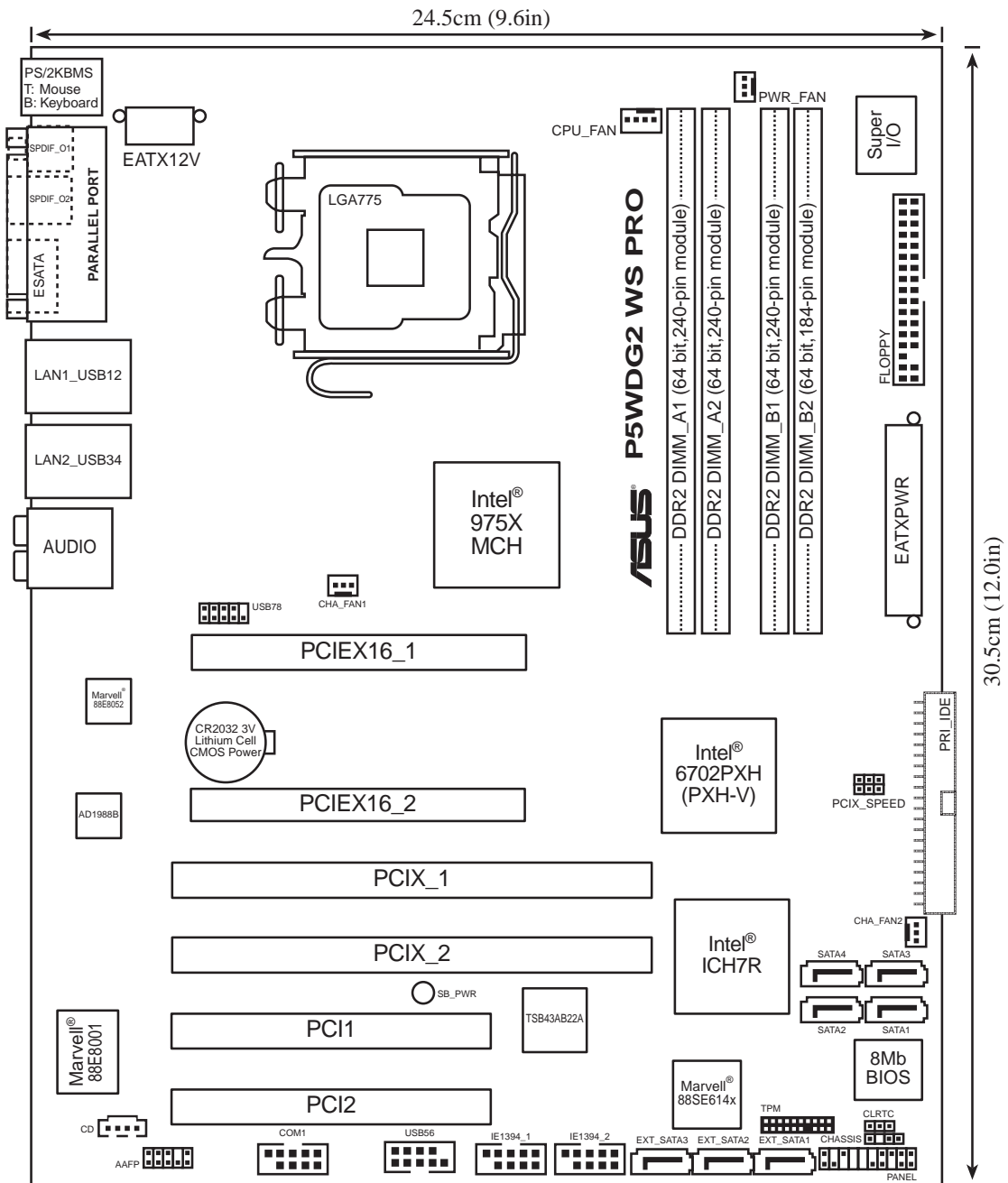

The Wireless LAN module and the USB port on the module are optional items and are grayed out in the above illustration.

2.2.5 Layout contents

Slots	Page
1. DDR2 DIMM slots	2-14
2. PCI Express x16 slots	2-22
3. PCI slots	2-22
4. PCI -X slots	2-22

Jumper	Page
1. Clear RTC RAM (3-pin CLRRTC)	2-27
2. PCIX speed setting (6-pin PCIX_SPEED)	2-28

Rear panel connectors	Page
1. PS/2 mouse port (green)	2-29
2. Parallel port	2-29
3. LAN1 (RJ-45) port	2-29
4. LAN2 (RJ-45) port	2-29
5. Rear Speaker Out port (black)	2-30
6. Center/Subwoofer port (orange)	2-30
7. Line In port (light blue)	2-30
8. Line Out port (lime)	2-30
9. Microphone port (pink)	2-30
10. Side Speaker Out port (gray)	2-30
11. USB 2.0 ports 3 and 4	2-30
12. USB 2.0 ports 1 and 2	2-30
13. External ATA port	2-31
14. Optical S/PDIF Out port	2-31
15. Coaxial S/PDIF Out port	2-31
16. PS/2 keyboard port (purple)	2-31

Internal connectors	Page
1. Floppy disk drive connector (34-1 pin FLOPPY)	2-32
2. Primary IDE connector (40-1 pin PRI_IDE)	2-32
3. ICH7R Serial ATA connectors (7-pin SATA1 [red], SATA2 [red], SATA3 [black], SATA4 [black])	2-33
4. Marvell® 88SE614x Serial ATA connectors (7-pin EXT_SATA1, EXT_SATA2, EXT_SATA3)	2-34
5. Optical drive audio connector (4-pin CD)	2-35
6. Front panel audio connector (10-1 pin AAFP)	2-35
7. USB connectors (10-1 pin USB56, USB78)	2-36
8. IEEE 1394a port connectors (10-1 pin IE1394_1 [Red]; 10-1 pin IE1394_2 [Red])	2-36
9. Chassis intrusion connector (4-1 pin CHASSIS)	2-37
10. CPU, Chassis, and Power Fan connectors (4-pin CPU_FAN, 3-pin PWR_FAN, 3-pin CHA_FAN1, 3-pin CHA_FAN2)	2-38
11. Serial port connector (10-1 pin COM1)	2-39
12. ATX power connectors (24-pin EATXPWR, 2x4-pin EATX12V)	2-39
13. TPM connector (20-1 pin TPM)	2-41
14. System panel connector (12-pin PANEL) <ul style="list-style-type: none"> • System power LED • Hard disk drive activity LED • System warning speaker • ATX power button/soft-off button • Reset button 	2-42

2.3 Central Processing Unit (CPU)

The motherboard comes with a surface mount LGA775 socket designed for the Intel® Pentium® 4/Celeron®/Intel® Pentium® D processor in the 775-land package.

This motherboard also supports the Intel® Pentium® Processor Extreme Edition, the latest CPU with embedded dual physical cores and Hyper-Threading technology, making four CPU threads possible. Refer to the table below for the operating system support status.

OS licensing support list	
Intel Dual-Core CPU support	Pentium® Processor Extreme Edition (supports Hyper-Threading Technology)
Windows® 2000 Professional	
Windows® 2000 Advanced Server	Windows® 2000 Advanced Server
Windows® XP Home	Windows® XP Home
Windows® XP Professional	Windows® XP Professional
Windows® Server 2003 - Standard, Enterprise	Windows® Server 2003 - Standard, Enterprise



If installing a dual-core CPU, connect the chassis fan cable to the CHA_FAN1 connector to ensure system stability.



- Upon purchase of the motherboard, make sure that the PnP cap is on the socket and the socket contacts are not bent. Contact your retailer immediately if the PnP cap is missing, or if you see any damage to the PnP cap/socket contacts/motherboard components. ASUS will shoulder the cost of repair only if the damage is shipment/transit-related.
 - Keep the cap after installing the motherboard. ASUS will process Return Merchandise Authorization (RMA) requests only if the motherboard comes with the cap on the LGA775 socket.
 - The product warranty does not cover damage to the socket contacts resulting from incorrect CPU installation/removal, or misplacement/loss/incorrect removal of the PnP cap.
-

2.3.1 Installing the CPU

To install a CPU:

1. Locate the CPU socket on the motherboard.

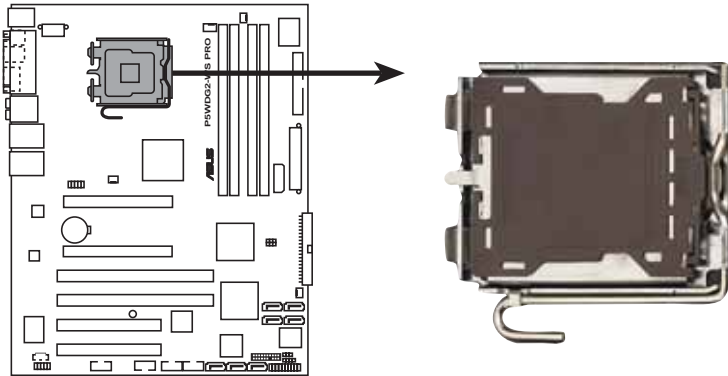

P5WDG2-WS PRO CPU Socket 775



Before installing the CPU, make sure that the socket box is facing towards you and the load lever is on your left.

2. Press the load lever with your thumb (A), then move it to the left (B) until it is released from the retention tab.

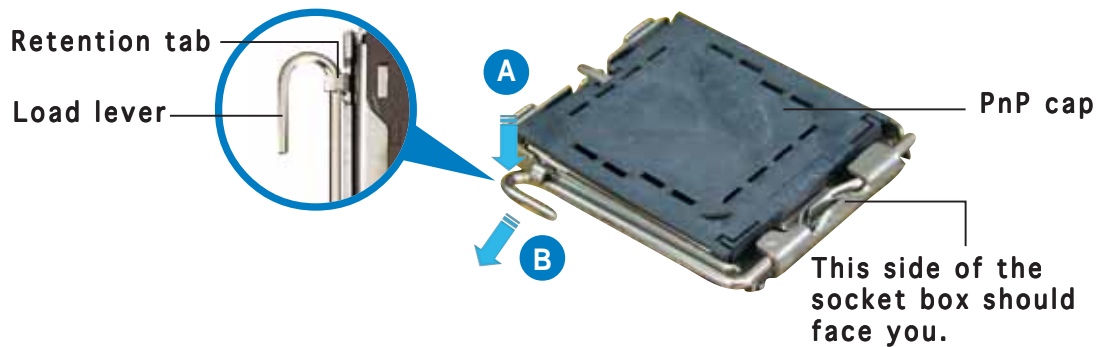

To prevent damage to the socket pins, do not remove the PnP cap unless you are installing a CPU.

3. Lift the load lever in the direction of the arrow to a 135° angle.

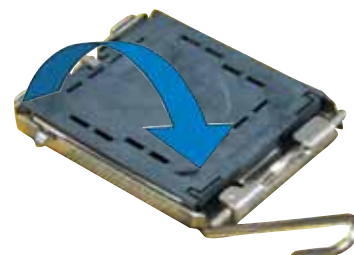

- Lift the load plate with your thumb and forefinger to a 100° angle (A), then push the PnP cap from the load plate window to remove (B).

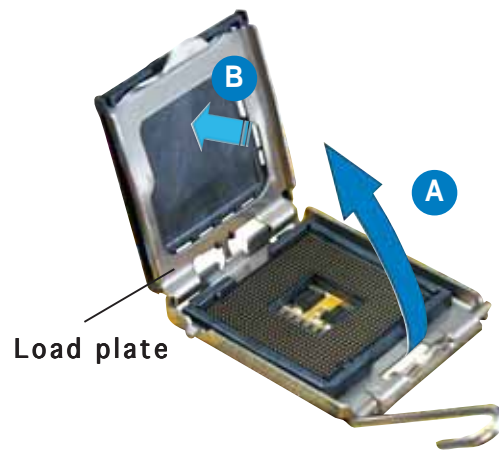

- Position the CPU over the socket, making sure that the gold triangle is on the bottom-left corner of the socket. The socket alignment key should fit into the CPU notch.

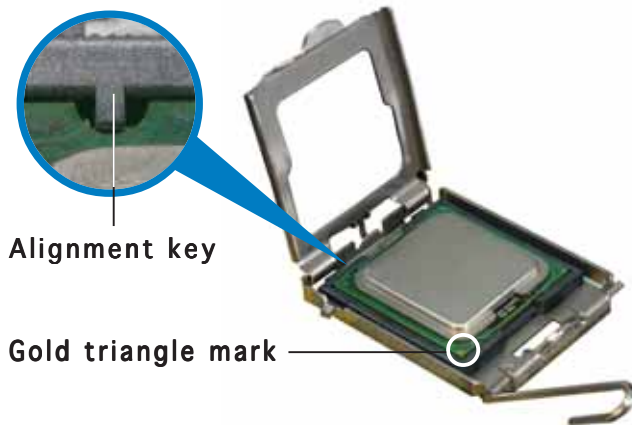

The CPU fits in only one correct orientation. DO NOT force the CPU into the socket to prevent bending the connectors on the socket and damaging the CPU!

- Close the load plate (A), then push the load lever (B) until it snaps into the retention tab.
- If installing a dual-core CPU, connect the chassis fan cable to the CHA_FAN1 connector to ensure system stability.

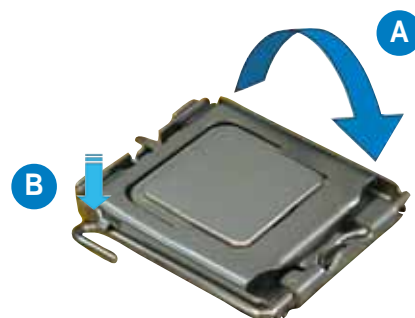

The motherboard supports Intel® Pentium® 4 LGA775 processors with the Intel® Enhanced Memory 64 Technology (EM64T), Enhanced Intel SpeedStep® Technology (EIST), and Hyper-Threading Technology. Refer to the Appendix for more information on these CPU features.

2.3.2 Installing the CPU heatsink and fan

The Intel® Pentium® 4 LGA775 processor requires a specially designed heatsink and fan assembly to ensure optimum thermal condition and performance.



- When you buy a boxed Intel® Pentium® 4 processor, the package includes the CPU fan and heatsink assembly. If you buy a CPU separately, make sure that you use only Intel®-certified multi-directional heatsink and fan.
- Your Intel® Pentium® 4 LGA775 heatsink and fan assembly comes in a push-pin design and requires no tool to install.
- If you purchased a separate CPU heatsink and fan assembly, make sure that you have properly applied Thermal Interface Material to the CPU heatsink or CPU before you install the heatsink and fan assembly.



Make sure that you have installed the motherboard to the chassis before you install the CPU fan and heatsink assembly.

To install the CPU heatsink and fan:

1. Place the heatsink on top of the installed CPU, making sure that the four fasteners match the holes on the motherboard.



Orient the heatsink and fan assembly such that the CPU fan cable is closest to the CPU fan connector.

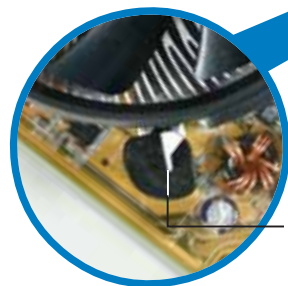

Narrow end of the groove



Motherboard hole
Fastener



Make sure to orient each fastener with the narrow end of the groove pointing outward. (The photo shows the groove shaded for emphasis.)

2. Push down two fasteners at a time in a diagonal sequence to secure the heatsink and fan assembly in place.

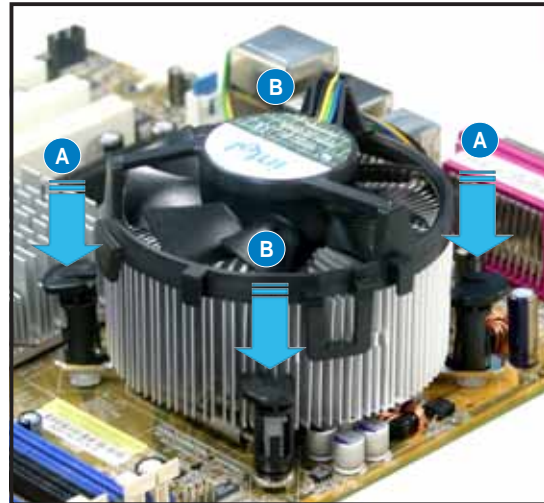
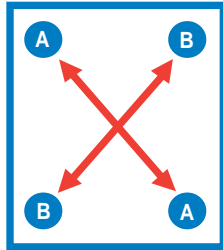

3. Connect the CPU fan cable to the connector on the motherboard labeled CPU_FAN.

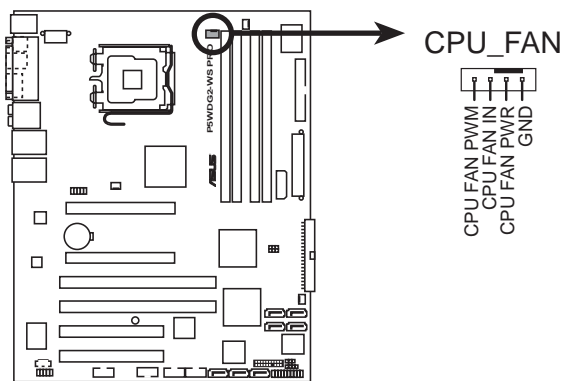

P5WDG2-WS PRO CPU fan connector



Do not forget to connect the CPU fan connector! Hardware monitoring errors can occur if you fail to plug this connector.

2.3.3 Uninstalling the CPU heatsink and fan

To uninstall the CPU heatsink and fan:

1. Disconnect the CPU fan cable from the connector on the motherboard.
2. Rotate each fastener counterclockwise.



3. Pull up two fasteners at a time in a diagonal sequence to disengage the heatsink and fan assembly from the motherboard.

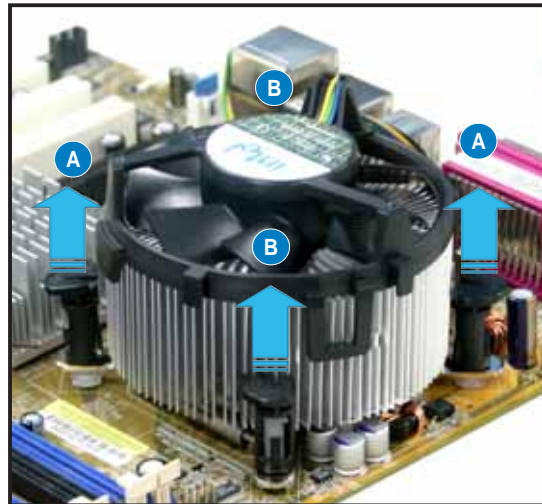
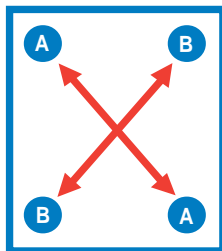

4. Carefully remove the heatsink and fan assembly from the motherboard.



5. Rotate each fastener clockwise to ensure correct orientation when reinstalling.

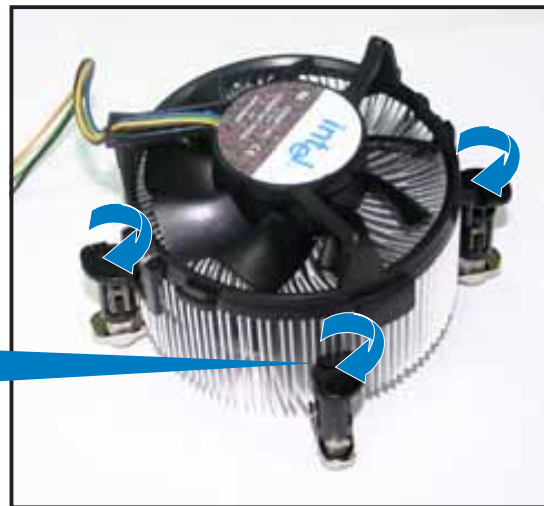
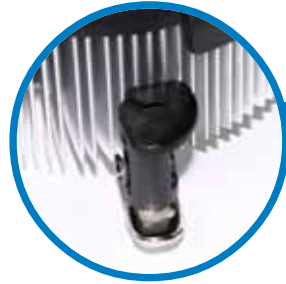

Narrow end of the groove



The narrow end of the groove should point outward after resetting. (The photo shows the groove shaded for emphasis.)

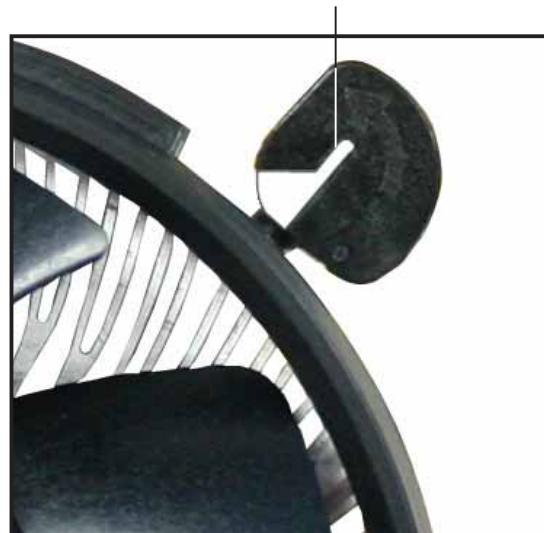

Refer to the documentation in the boxed or stand-alone CPU fan package for detailed information on CPU fan installation.

2.4 System memory

2.4.1 Overview

The motherboard comes with four Double Data Rate 2 (DDR2) Dual Inline Memory Modules (DIMM) sockets.

A DDR2 module has the same physical dimensions as a DDR DIMM but has a 240-pin footprint compared to the 184-pin DDR DIMM. DDR2 DIMMs are notched differently to prevent installation on a DDR DIMM socket.

The figure illustrates the location of the DDR2 DIMM sockets:

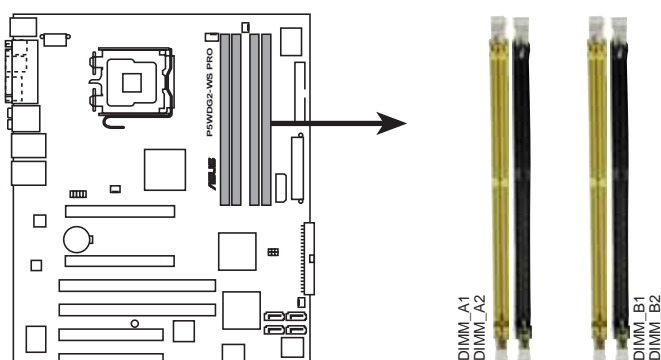

P5WDG2-WS PRO 240-pin DDR2 DIMM sockets

Channel	Sockets
Channel A	DIMM_A1 and DIMM_A2
Channel B	DIMM_B1 and DIMM_B2

2.4.2 Memory configurations

You may install 256 MB, 512 MB, 1 GB, and 2 GB unbuffered ECC and non-ECC DDR2 DIMMs into the DIMM sockets.



- For dual-channel configuration, the total size of memory module(s) installed per channel must be the same (DIMM_A1 + DIMM_A2 = DIMM_B1 + DIMM_B2).
- Always install DIMMs with the same CAS latency. For optimum compatibility, it is recommended that you obtain memory modules from the same vendor. Visit the ASUS website (www.asus.com) for the latest Qualified Vendors List.
- Due to chipset resource allocation, the system may detect less than 8 GB system memory when you installed four 2 GB DDR2 memory modules.
- This motherboard does not support memory modules made up of 128 Mb chips or double sided x16 memory modules.



Important notice on installing Windows® XP 32-bit version

If you install Windows® XP 32-bit version Operating System (OS), the limitation of this OS version is that it may reserve a certain amount of memory space for system devices. We recommend that you install less than 3 GB system memory if you would like to work under Windows® XP 32-bit version OS. The excess memory installation will not cause any usage problem, but it will not give users the benefit of manipulating this excess memory space.

Visit the ASUS FAQ site for further explanation:

<http://support.asus.com/faq/faq.aspx?SLanguage=en-us>

Under **General search**, make the selections as shown, then click **Search**. Click the article titled **“4GB memory installed but less memory size detected.”**



You also may check the URLs below for third party comments on this issue:

http://dlsvr01.asus.com/pub/ASUS/mb/4GB_Rev1.pdf

<http://www.intel.com/support/motherboards/server/sb/cs-016594.htm>



Notes on memory limitations

- Due to chipset limitation, this motherboard can only support up to 8 GB on the operating systems listed below. You may install a maximum of 2 GB DIMMs on each slot, but only DDR2-533 2 GB density modules are available for this configuration.

32-bit	64-bit
Windows® 2000 Advanced Server	Windows® Server 2003 Standard x64 Edition
Windows® Server 2003 Enterprise Edition	Windows® XP Professional x64 Edition
	Windows® Server 2003 Enterprise x64 Edition

- Some old-version DDR2-667 DIMMs may not match Intel®'s On-Die-Termination (ODT) requirement and will automatically downgrade to run at DDR2-533. If this happens, contact your memory vendor to check the ODT value.
- Due to chipset limitation, DDR2-667 with CL=4 will be downgraded to run at DDR2-533 by default setting. If you want to operate with lower latency, adjust the memory timing manually.
- Due to chipset limitation, DDR2-533 with CL=3 will be downgraded to run at DDR2-400 by default setting. If you want to operate with lower latency, adjust the memory timing manually.

Qualified Vendors Lists (QVL)

DDR2-800 MHz capability

Size	Vendor	Chip No.	Brand	Side(s)	Part No.	DIMM support			
						CL	A	B	C
512MB	KINGSTON	K4T51083QC	-	SS	KVR800D2N5/512		•	•	
1024MB	KINGSTON	K4T51083QC	-	DS	KVR800D2N5/1G		•	•	
1024MB	KINGSTON	Heat-Sink Package	-	DS	KHX6400D2LL/1G		•		
512MB	SAMSUNG	EDD339XX	-	SS	M378T6553CZ3-CE7		•		
256MB	SAMSUNG	K4T51163QC-ZCE7	-	SS	M378T3354CZ3-CE7		•	•	
512MB	Qimonda	HYB18T256800AF25	-	DS	HYS64T64520HU-2.5-A		•	•	
512MB	Hynix	HY5PS12821BFP-S5	-	SS	HYMP564U64BP8-S5		•	•	
1024MB	Hynix	HY5PS12821BFP-S5	-	DS	HYMP512U64BP8-S5		•	•	
512MB	MICRON	5JAIIZ9DQQ	-	SS	MT8HTF6464AY-80EA3		•	•	
1024MB	MICRON	5JAIIZ9DQQ	-	DS	MT16HTF12864AY-80EA3		•	•	
512MB	MICRON	5ZD22D9GKX	-	SS	MT8HTF6464AY-80ED4		•	•	
1024MB	MICRON	5ZD22D9GKX	-	DS	MT16HTF12864AY-80ED4		•	•	
512MB	MICRON	6CD22D9GKX	-	SS	MT8HTF6464AY-80ED4		•	•	
1024MB	MICRON	6CD22D9GKX	-	DS	MT16HTF12864AY-80ED4		•	•	
512MB	CORSAIR	Heat-Sink Package	-	SS	CM2X512A-6400		•		
1024MB	CORSAIR	Heat-Sink Package	-	DS	CM2X1024-6400C4		•	•	
512MB	A-DATA	AD29608A8A-25EG	-	SS	M20AD6G3H31601E5E		•	•	
512MB	Crucial	Heat-Sink Package	-	SS	BL6464AA804.8FD		•	•	
1024MB	Crucial	Heat-Sink Package	-	DS	BL12864AA804.16FD		•	•	
256MB	Apacer	E2508AB-GE-E	-	SS	78.81091.420		•	•	

DDR2-667 MHz capability

Size	Vendor	Chip No.	Brand	Side(s)	Part No.	DIMM support			
						CL	A	B	C
512MB	KINGSTON	E5108AE-6E-E	-	SS	KVR667D2N5/512		•	•	
1024MB	KINGSTON	E5108AE-6E-E	-	DS	KVR667D2N5/1G		•	•	
512MB	KINGSTON	E5108AE-6E-E	-	SS	KVR667D2E5/512		•	•	
256MB	KINGSTON	HYB18T256800AF3	-	SS	KVR667D2N5/256		•	•	
512MB	SAMSUNG	K4T56083QF-ZCE6	-	DS	M378T6453FZ0-CE6		•		
256MB	SAMSUNG	K4T51163QC-ZCE6	-	SS	M378T3354CZ0-CE6		•	•	
512MB	SAMSUNG	ZCE6K4T51083QC	-	SS	M378T6553CZ0-CE6		•	•	
1024MB	SAMSUNG	ZCE6K4T51083QC	-	DS	M378T2953CZ0-CE6		•		
512MB	MICRON	4VB41D9CZM	-	DS	MT16HTF6464AY-667B4		•	•	
256MB	Infineon	HYB18T512160AF-3S	-	SS	HYS64T32000HU-3S-A		•	•	
512MB	Infineon	HYB18T512800AF3S	-	SS	HYS64T64000HU-3S-A		•	•	
1024MB	Infineon	HYB18T512800AF3S	-	DS	HYS64T128020HU-3S-A		•	•	
512MB	Infineon	HYB18T512800AF3S(ECC)	-	SS	HYS72T64000HU-3S-A		•	•	
256MB	Infineon	HYB18T256800AF3S(ECC)	-	SS	HYS72T32000HU-3S-A		•	•	
1024MB	Infineon	HYB18T512800AF3S(ECC)	-	DS	HYS72T128020HU-3S-A		•		
512MB	Infineon	HYB18T512800BF3S(ECC)	-	SS	HYS72T64000HU-3S-B		•	•	
1024MB	Infineon	HYB18T512800BF3S(ECC)	-	DS	HYS72T128020HU-3S-B		•	•	
256MB	Infineon	HYB18T512160BF-3S	-	SS	HYS64T32000HU-3S-B		•	•	
512MB	Infineon	HYB18T512800BF3S	-	SS	HYS64T64000HU-3S-B		•	•	
1024MB	Infineon	HYB18T512800BF3S	-	DS	HYS64T128020HU-3S-B		•	•	
512MB	Hynix	HY5PS12821AFP-Y5	-	SS	HYMP564U64AP8-Y5		•	•	

(Continued on the next page)

DDR2-667 MHz capability

Size	Vendor	Chip No.	Brand	Side(s)	Part No.	DIMM support			
						CL	A	B	C
1024MB	Hynix	HY5PS12821AFP-Y5	-	DS	HYMP512U64AP8-Y5		•	•	
1024MB	Hynix	HY5PS1G831FP-Y5(ECC)	-	SS	HYMP112U72P8-Y5				•
512MB	Hynix	HY5PS12821AFP-Y5(ECC)	-	SS	HYMP564U72AP8-Y5		•	•	
1024MB	Hynix	HY5PS12821AFP-Y5(ECC)	-	DS	HYMP512U72AP8-Y5		•	•	
512MB	Hynix	HY5PS12821AFP-Y4	-	SS	HYMP564U64AP8-Y4		•	•	
512MB	Hynix	HY5PS12821AFP-Y4(ECC)	-	SS	HYMP564U72AP8-Y4		•	•	
1024MB	Hynix	HY5PS12821AFP-Y4(ECC)	-	DS	HYMP512U72AP8-Y4				•
512MB	ELPIDA	E5108AE-6E-E	-	SS	EBE51UD8AEFA-6E-E		•	•	
1024MB	ELPIDA	Engineering Sample	-	DS	EBE11UD8AEFA-6E-E				•
512MB	crucial	Heat-Sink Package	-	DS	BL6464AL664.16FB		•	•	
1024MB	crucial	Heat-Sink Package	-	DS	BL12864AL664.16FA		•	•	
512MB	Kingmax	E5108AE-6E-E	-	SS	KLCC28F-A8EB5		•	•	
1024MB	Kingmax	E5108AE-6E-E	-	DS	KLCD48F-A8EB5		•	•	
512MB	Apacer	E5108AE-6E-E	-	SS	78.91092.420				•
1024MB	Apacer	E5108AE-6E-E	-	DS	78.01092.420		•	•	
512MB	A-DATA	E5108AE-6E-E	-	SS	M20EL5G3H3160B1C0Z		•	•	
512MB	A-DATA	AD29608A8B-3EG	-	SS	M20AD5Q3H3163J1C52		•	•	
512MB	Transcend	E5108AE-6E-E	-	SS	TS64MLQ64V6J				•
1024MB	Transcend	E5108AE-6E-E	-	DS	TS128MLQ64V6J				•

Side(s): **SS** - Single-sided **DS** - Double-sided

DIMM support:

- A** - Supports one module inserted into either slot, in Single-channel memory configuration.
- B** - Supports one pair of modules inserted into either Channel A or Channel B as one pair of Dual-channel memory configuration.
- C** - Supports four modules inserted into the yellow and black slots as two pairs of Dual-channel memory configuration.



Visit the ASUS website for the latest DDR2-800/667 MHz QVL.

DDR2-533 MHz capability

Size	Vendor	Chip No.	Brand	Side(s)	Part No.	DIMM support			
						CL	A	B	C
512MB	KINGSTON	HYB18T512800AF37	-	SS	KVR533D2N4/512		•	•	
1024MB	KINGSTON	5YDIID9GCT	-	DS	KVR533D2N4/1G				•
256MB	SAMSUNG	K4T56083QF-GCD5	-	SS	M378T3253FG0-CD5		•	•	
512MB	SAMSUNG	K4T56083QF-GCD5(ECC)	-	DS	M391T6453FG0-CD5		•	•	
1024MB	SAMSUNG	K4T51083QB-GCD5(ECC)	-	DS	M391T2953BG0-CD5		•	•	
512MB	Infineon	HYB18T512800AC37	-	SS	HYS64T6400GU-3.7-A				•
256MB	Infineon	HYB18T512160AF-3.7	-	SS	HYS64T3200HU-3.7-A				•
512MB	Infineon	HYB18T512800AF37	-	SS	HYS64T6400HU-3.7-A				•
1024MB	Infineon	HYB18T512800AF37	-	DS	HYS64T128020HU-3.7-A		•	•	
256MB	Infineon	HYB18T5121608BF-3.7	-	SS	HYS64T3200HU-3.7-B		•	•	
512MB	Infineon	HYB18T512800BF37	-	SS	HYS64T6400HU-3.7-B		•	•	
1024MB	Infineon	HYB18T512800BF37	-	DS	HYS64T128020HU-3.7-B		•	•	
256MB	Infineon	HYB18T256800AF37(ECC)	-	SS	HYS72T3200HU-3.7-A		•	•	
512MB	Hynix	HY5PS12821F-C4	-	SS	HYMP564U648-C4		•	•	
1024MB	Hynix	HY5PS12821F-C4	-	DS	HYMP512U648-C4		•	•	
1024MB	Hynix	HY5PS12821F-C4(ECC)	-	DS	HYMP512U728-C4		•	•	
512MB	Hynix	HY5PS12821FP-C4(ECC)	-	SS	HYMP564U728-C4		•	•	
512MB	Hynix	HY5PS12821AFP-C3	-	SS	HYMP564U64AP8-C3		•	•	
1024MB	Hynix	HY5PS12821AFP-C3	-	DS	HYMP512U64AP8-C3		•	•	
512MB	ELPIDA	E5108AB-5C-E(ECC)	-	SS	EBE51ED8ABFA-5C-E		•	•	
512MB	ELPIDA	E5108AB-5C-E	-	SS	EBE51UD8ABFA-5C				•
512MB	ELPIDA	E5108AB-5C-E	-	SS	EBE51UD8ABFA-5C-E		•	•	
1024MB	ELPIDA	E5108AB-5C-E	-	DS	EBE11UD8ABFA-5C-E				•
256MB	CORSAIR	MIII0051832M8CEC	-	SS	VS256MB533D2				•
512MB	CORSAIR	MII10052432M8CEC	-	DS	VS512MB533D2				•
256MB	Apacer	E5116AB-5C-E	-	SS	78.81077.420		•	•	
512MB	KINGMAX	E5108AE-5C-E	-	SS	KLBC28F-A8EB4		•	•	
1024MB	KINGMAX	E5108AE-5C-E	-	DS	KLBD48F-A8EB4		•	•	
512MB	KINGMAX	KKEA88E4AAK-37	-	SS	KLBC28F-A8KE4		•	•	
1024MB	KINGMAX	5MB22D9DCN	-	DS	KLBD48F-A8ME4		•	•	
512MB	Transcend	K4T51083QB-GCD5	-	SS	TS64MLQ64V5J		•	•	
1024MB	Transcend	K4T51083QB-GCD5	-	DS	TS128MLQ64V5J				•

Side(s): **SS** - Single-sided **DS** - Double-sided

DIMM support:

- A** - Supports one module inserted into either slot, in Single-channel memory configuration.
- B** - Supports one pair of modules inserted into either Channel A or Channel B as one pair of Dual-channel memory configuration.
- C** - Supports four modules inserted into the yellow and black slots as two pairs of Dual-channel memory configuration.



Visit the ASUS website for the latest DDR2-533 MHz QVL.

2.4.3 Installing a DIMM



Unplug the power supply before adding or removing DIMMs or other system components. Failure to do so can cause severe damage to both the motherboard and the components.

To install a DIMM:

1. Unlock a DIMM socket by pressing the retaining clips outward.
2. Align a DIMM on the socket such that the notch on the DIMM matches the break on the socket.
3. Firmly insert the DIMM into the socket until the retaining clips snap back in place and the DIMM is properly seated.

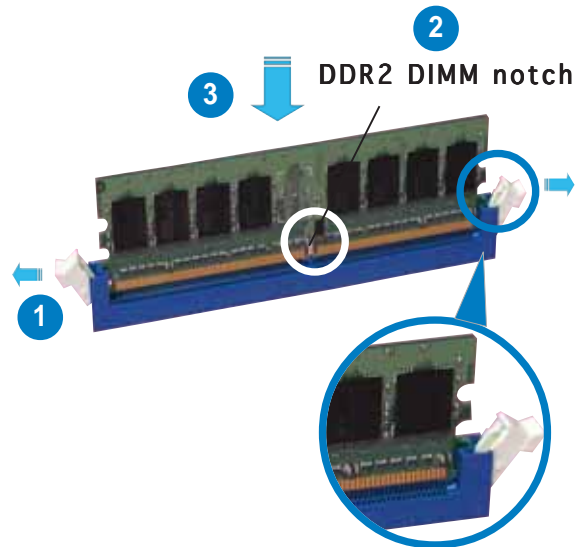

Unlocked retaining clip



- A DDR2 DIMM is keyed with a notch so that it fits in only one direction. Do not force a DIMM into a socket to avoid damaging the DIMM.
- The DDR2 DIMM sockets do not support DDR DIMMs. Do not install DDR DIMMs to the DDR2 DIMM sockets.

2.4.4 Removing a DIMM

To remove a DIMM:

1. Simultaneously press the retaining clips outward to unlock the DIMM.



Support the DIMM lightly with your fingers when pressing the retaining clips. The DIMM might get damaged when it flips out with extra force.

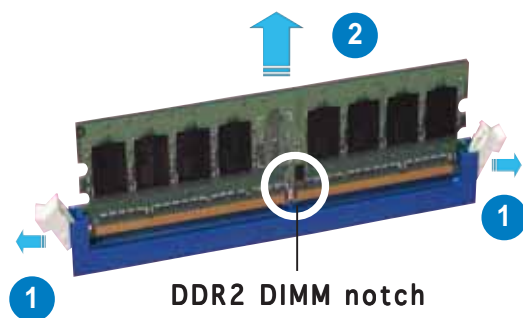

2. Remove the DIMM from the socket.

2.5 Expansion slots

In the future, you may need to install expansion cards. The following sub-sections describe the slots and the expansion cards that they support.



Make sure to unplug the power cord before adding or removing expansion cards. Failure to do so may cause you physical injury and damage motherboard components.

2.5.1 Installing an expansion card

To install an expansion card:

1. Before installing the expansion card, read the documentation that came with it and make the necessary hardware settings for the card.
2. Remove the system unit cover (if your motherboard is already installed in a chassis).
3. Remove the bracket opposite the slot that you intend to use. Keep the screw for later use.
4. Align the card connector with the slot and press firmly until the card is completely seated on the slot.
5. Secure the card to the chassis with the screw you removed earlier.
6. Replace the system cover.

2.5.2 Configuring an expansion card

After installing the expansion card, configure the it by adjusting the software settings.

1. Turn on the system and change the necessary BIOS settings, if any. See Chapter 4 for information on BIOS setup.
2. Assign an IRQ to the card. Refer to the tables on the next page.
3. Install the software drivers for the expansion card.



When using PCI cards on shared slots, ensure that the drivers support “Share IRQ” or that the cards do not need IRQ assignments. Otherwise, conflicts will arise between the two PCI groups, making the system unstable and the card inoperable. Refer to the table on the next page for details.

2.5.3 Interrupt assignments

Standard interrupt assignments

IRQ	Priority	Standard Function
0	1	System Timer
1	2	Keyboard Controller
2	—	Re-direct to IRQ#9
3	11	IRQ holder for PCI steering*
4	12	Communications Port (COM1)*
5	13	IRQ holder for PCI steering*
6	14	Floppy Disk Controller
7	15	Printer Port (LPT1)*
8	3	System CMOS/Real Time Clock
9	4	IRQ holder for PCI steering*
10	5	IRQ holder for PCI steering*
11	6	IRQ holder for PCI steering*
12	7	PS/2 Compatible Mouse Port*
13	8	Numeric Data Processor
14	9	Primary IDE Channel
15	10	Secondary IDE Channel

* These IRQs are usually available for ISA or PCI devices.

IRQ assignments for this motherboard

	A	B	C	D	E	F	G	H
PCI slot 1	—	—	—	—	—	shared	—	—
PCI slot 2	—	—	—	—	—	—	shared	—
PCIX slot 1	—	—	shared	—	—	—	—	—
PCIX slot 2	—	—	—	shared	—	—	—	—
Onboard SATA	shared	—	—	—	—	—	—	—
Onboard 1394	—	—	—	—	—	shared	—	—
Onboard LAN 1/2	shared	—	—	—	—	shared	—	—
PCIe x16 1	shared	—	—	—	—	—	—	—
PCIe x16 2	shared	—	—	—	—	—	—	—
USB controller 1	shared	—	—	—	—	—	—	—
USB controller 2	—	shared	—	—	—	—	—	—
USB controller 3	—	—	shared	—	—	—	—	—
USB controller 4	—	—	—	shared	—	—	—	—
USB 2.0 controller	shared	—	—	—	—	—	—	—
Serial ATA	—	shared	—	—	—	—	—	shared
HD Audio	shared	—	—	—	—	—	—	—

2.5.4 PCI Express x16 slots

This motherboard supports two ATI CrossFire™ PCI Express x16 graphics cards that comply with the PCI Express specifications. The figure shows two graphics cards installed on the PCI Express x16 slots.

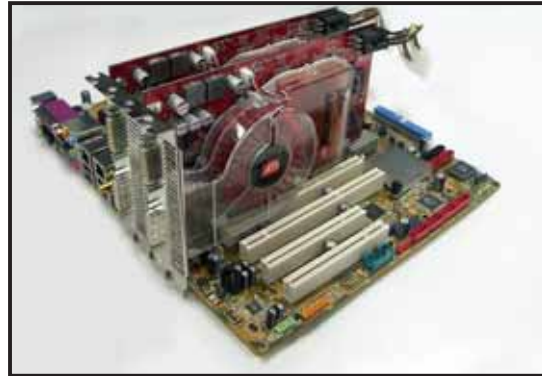

Refer to the next page for the list of qualified PCI Express x16 graphics cards for this motherboard.



- **In CrossFire™ mode**, install the master card in PCIEX16_1 (blue slot). Each PCI Express x16 slot works at x8 bandwidth.
- **In single card mode**, install the VGA card in PCIEX16_1 (blue slot) to avail of full x16 bandwidth. Installing in PCIEX16_2 (black slot) will cause the card to run at x8 bandwidth only.
- Connect the EZ Plug™ when using two graphics cards and a 20-pin ATX power supply, or if the cards do not have auxiliary power plugs.

2.5.5 PCI slots

The PCI slots support cards such as a LAN card, SCSI card, USB card, and other cards that comply with PCI specifications. The figure shows a LAN card installed on a PCI slot.

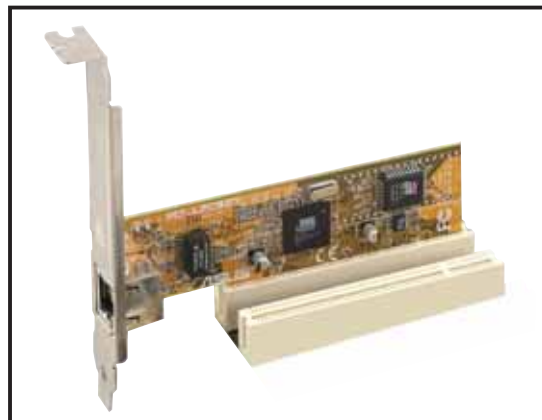

2.5.6 PCI-X slots

The PCI-X slots support cards such as a LAN card, SCSI card, USB card, and other cards that comply with PCI-X 1.0 specifications. The figure shows a RAID card installed on a PCI-X slot.



Qualified PCI Express x16 graphics cards

Model	Connect Interface	OS Environment	Status	Chipset/Driver Version
ASUS EAX300 Rev: V1.00 (BIOS: V5b60.8.15.117.0)	PCIEX16_1	WinXP Pro.	Pass	ATI Radeon X300 V8.231.0.0
ASUS EAX300SE-HM128 Rev: V1.00 (BIOS: V008.015.128.000)	PCIEX16_1	WinXP Pro.(JPN)	Pass	ATI Radeon X300SE (Hyper Memory)
ASUS EAX300SE-X Rev: V1.00 (BIOS: V008.015.117.000)	PCIEX16_1 PCIEX16_2	Win2003-64 Standard R2	Pass	ATI Radeon X300SE V8.252.0.0
ASUS EAX550 128 (BIOS: V5B60.8.15.139. AS05)	PCIEX16_1	Win2000 Pro.	Pass	ATI Radeon X550 V8.241.0.0
ASUS EAX550GE 256M (BIOS: V5B60.8.15.139. AS01)	PCIEX16_1	WinXP-64 Pro.	Pass	ATI Radeon X550 V8.252.0.0
ASUS EAX600XT Rev. V1.02 (BIOS: V113-AA20306-100-AS)	PCIEX16_1	WinXP Pro.	Pass	ATI Radeon X600XT V8.252.0.0
ASUS EAX700 (BIOS: V5E4D.9.7.1.3. A901)	PCIEX16_1	WinXP Pro.	Pass	ATI Radeon X700 V8.231.0.0
ASUS EAX700-X 128M Rev. V1.00a (BIOS: V009.008.001.004)	PCIEX16_1	WinXP Pro.	Pass	ATI Radeon X700LE V8.252.0.0
ASUS EAX700LE 128M (BIOS: V5E4D.9. 8.1.4. AS13)	PCIEX16_1 PCIEX16_2	WinXP Pro.(JPN)	Pass	ATI Radeon X700LE V8.252.0.0
ASUS EAX700PRO Rev. V1.00 (BIOS: V113-AA.30602-100)	PCIEX16_1	WinXP Pro. (JPN) PCIEX16_2	Pass	ATI Radeon X700PRO V8.252.0.0
ASUS EAX800PRO Rev. V1.00 (BIOS: V5549.9.4.1.10.AS)	PCIEX16_1	Win2003 Standard	Pass	ATI Radeon X800PRO V8.241.0.0
ASUS EAX800XL Rev. V1.00 (BIOS: V554D.9.7.1.AS02)	PCIEX16_1	WinXP Pro.(CHT)	Pass	ATI Radeon X800XL V8.241.0.0
ASUS EAX850PRO (BIOS: V5D4F.9.7. 1.4.AS02)	PCIEX16_1	WinXP Pro.	Pass	ATI Radeon X850PRO V8.241.0.0
ASUS EAX850XT 256MB Rev. PN: 109-A47401-10 (BIOS: V009.007.001.004)	PCIEX16_1 PCIEX16_2	Win2003-64 Standard R2	Pass	ATI Radeon X850XT V8.231.0.0
ASUS EAX850XT PE Rev. PN: 109-A47401-10 (BIOS: V009.007.001.004)	PCIEX16_1	Win2003 Standard	Pass	ATI Radeon X850XT PE V8.241.0.0
ASUS EAX1300 (BIOS: V113.AA77100.102)	PCIEX16_1	WinXP Pro.	Pass	ATI Radeon X1300 V8.231.0.0
ASUS EAX1600XT Silent 256MB V.1.00 (BIOS: 71C0.9.12.4.2)	PCIEX16_1	WinXP Pro.	Pass	ATI Radeon X1600XT V8.241.0.0
ASUS EAX1800XT 512MB (BIOS: V7100.9.12. 4.2.AS01)	PCIEX16_1 PCIEX16_2	WinXP Pro. (CHT)	Pass	ATI Radeon X1800XT V8.241.0.0
ASUS EAX1900XTX (BIOS: V009.012.005.002)	PCIEX16_1 PCIEX16_2 (CrossFire)	WinXP Pro.	Pass	ATI Radeon X1900XTX V8.241.0.0
ASUS EAX1900CrossFire (BIOS: 7249.9.12.5.2AS05)	PCIEX16_1 (CrossFire) PCIEX16_2 (CrossFire)	WinXP Pro.	Pass	ATI Radeon X1900CF V8.241.0.0
ASUS EN5900 Rev. 1.01(BIOS: V04.35.20.45)	PCIEX16_1	WinXP Pro.	Pass	nVIDIA GeForce PCX5900 V6.14.10.8198
ASUS EN6200GE Rev V1.00A (BIOS: V5.43.02.27.AS07)	PCIEX16_1 PCIEX16_2	Win2003-64 Standard R2	Pass	nVIDIA GeForce 6200 V6.14.10.8198

(Continued on the next page)

Qualified PCI Express x16 graphics cards

Model	Connect Interface	OS Environment	Status	Chipset/Driver Version
ASUS EN6500 128M Rev V1.02 (BIOS: V5.44.02.45.0)	PCIEX16_1	WinXP Pro.	Pass	nVIDIA GeForce 6500 V6.14.10.8425
ASUS EN6600GT Rev. V1.00 (BIOS: V5.43.02.16.AS27)	PCIEX16_1	WinXP Pro.	Pass	nVIDIA GeForce 6600GT V6.14.10.8198
ASUS EN6800 Rev. V1.00 (BIOS: V5.41.02.17.AS01)	PCIEX16_1	WinXP Pro.(CHT)	Pass	nVIDIA GeForce 6800 V6.14.10.8198
ASUS EN6800LE Rev. V1.00 (BIOS: V5.41.02.34.AS01)	PCIEX16_1	WinXP Pro.	Pass	nVIDIA GeForce 6800LE V6.14.10.8425
ASUS EN6800GT Rev. V1.02 (BIOS: V5.40.02.26.AS05)	PCIEX16_1	WinXP Pro.(CHT)	Pass	nVIDIA GeForce 6800GT V6.14.10.8198
ASUS EN6800ULTRA (BIOS: V5.40.02.32.AS07)	PCIEX16_1 PCIEX16_2	Win2003-64 Standard R2	Pass	nVIDIA GeForce 6800ULTRA V6.14.10.8198
ASUS EN7600GT Silent/256M (Bios: V5.73.22.15.01)	PCIEX16_1	Win2003 Standard	Pass	nVIDIA GeForce 7600GT V6.14.10.8198
ASUSEN7600GT/256MB (Bios: V5.73.22.15.02)	PCIEX16_1	WinXP Pro.	Pass	nVIDIA GeForce 7600GT
ASUS EN7800GTX 256MB (BIOS: V5.70.02.11.01)	PCIEX16_1	WinXP-64 Pro.	Pass	nVIDIA GeForce 7800GTX V6.14.10.8425
ASUS EN7900GTX 512MX16 (Bios: V5.71.22.12.01)	PCIEX16_1	WinXP Pro.	Pass	nVIDIA GeForce 7900GTX V6.14.10.8421
ASUS EN7950GX2 1024MX16 (Bios: V5.71.24.06)	PCIEX16_1	WinXP Pro.	Pass	nVIDIA GeForce 7950*2
ATI Radeon X850 CrossFire (BIOS: V009.010.001.015)	PCIEX16_1 PCIEX16_2	WinXP Pro.	Pass	ATI Radeon X850 V8.241.0.0
ELSA Falcox X85 XT 256B3 DTV Rev: PN: 109 A47401-10 (BIOS: 009.007.001.004)	PCIEX16_1	WinXP Pro.(CHT)	Pass	ATI Radeon X850 XT V8.241.0.0
Elsa Gladiac 660GT 128MB3 Rev: 2B(BIOS: V5.43.02.46.E1)	PCIEX16_1 PCIEX16_2	Win2003-64 Standard R2	Pass	nVIDIA GeForce 6600GT V6.14.10.8198
ELSA Gladiac 780GTX 256B3 (BIOS: V5.70.02.11.E1)	PCIEX16_1	Win2000 Pro.	Pass	nVIDIA GeForce 7800GTX V6.14.10.8198
Gecube RADEON X1600XT (BIOS:V133.A671B2.102)	PCIEX16_1 PCIEX16_2	Win2003-64 Standard R2	Pass	ATI Radeon X1600XT V8.231.0.0
GIGABYTE-GV- NX79T256DBRH-256MX16 (BIOS5.71.22.12.02)	PCIEX16_1	WinXP Pro.(CHT)	Pass	nVIDIA GeForce 7900 GT
Gigabyte GV-RX70P128D Rev: 1.1 (BIOS: V009.004.001.032)	PCIEX16_1	WinXP Pro.(CHT)	Pass	ATI Radeon X700PRO
Leadtek WinFast PX6200 TD Rev. A1 (BIOS: V5.43.02.36.68)	PCIEX16_1	WinXP Pro.	Pass	nVIDIA GeForce 6200 V6.14.10.8198
Leadtek WinFast PX6600GT TDH Rev. A (BIOS: V5.43.02.16)	PCIEX16_1	WinXP Pro.	Pass	nVIDIA GeForce 6600GT V6.14.10.8198
Leadtek WinFast PX6800GT TD256M Rev. C1 (BIOS: V5.40.02.32)	PCIEX16_1	WinXP-64 Pro.	Pass	nVIDIA GeForce 6800GT V6.14.10.8198
Leadtek WinFast 128MX16 PX7300GS (BIOS:5.72.22.34.68)	PCIEX16_2	WinXP Pro. (CHT)	Pass	nVIDIA GeForce 7300GS V6.14.10.8198
PowerColor Radeon X800GT256M (BIOS: V009.010.001.015)	PCIEX16_1	WinXP Pro.	Pass	ATI Radeon X800GT V8.231.0.0

Qualified PCI Express x16 graphics cards (Workstation level)

Model	Connect Interface	OS Environment	Status	Chipset/Driver Version
3Dlabs Wildcat Realizm 500 256M Rev. 08 (BIOS: V3.37)	PCIEX16_1	WinXP Pro.(CHT)	Pass	3Dlabs Wildcat Realizm P25 V4.5.854.0
ASUS EN6200TC128/T/16M Rev V1.01 (BIOS: V5.44.02.11)	PCIEX16_1	WinXP-64 Pro.	Pass	nVIDIA GeForce 6200 (with Turbo cache) V6.14.10.8425
ASUS EN6600 256M Rev V1.00A (BIOS: V5.43.02.16.AS11)	PCIEX16_1	WinXP-64 Pro.	Pass	nVIDIA GeForce 6600 V6.14.10.8425
ASUS EN7800GT 256MB Rev: V1.00 (BIOS: V5.70.02.13.AS01)	PCIEX16_1 PCIEX16_2	Win2003-64 Standard R2	Pass	nVIDIA GeForce 7800GT V6.14.10.8198
ATI FireMV2200 (BIOS: V113.A25915.100)	PCIEX16_1	WinXP Pro.	Pass	ATI FireMV 2200 V8.263.0.0\
ELSA Gladiac 660LE 256MB Rev: 3C (BIOS: V5.43.02.69.E2)	PCIEX16_1	WinXP Pro. (CHT)	Pass	nVIDIA GeForce 6600LE V6.14.10.8198
ELSA ATI Fire GL V3100 (BIOS: V113.A33429.100)	PCIEX16_1	WinXP Pro.	Pass	ATI FireGL V3100 V6.14.10.6521
Gigabyte GV-NX62TC256D8 (BIOS: V5.44.02.32)	PCIEX16_1	Win2000 Pro.	Pass	nVIDIA GeForce 6200TC V6.14.10.8198
Leadtek WinFast PX6200TC 64M Rev. A (BIOS: V5.44.02.18)	PCIEX16_1	WinXP Pro.	Pass	nVIDIA GeForce 6200 (with Turbo cache) V6.14.10.8198
Leadtek Quadro FX540 128M (BIOS:V5.43.02.64.35)	PCIEX16_1	WinXP Pro.	Pass	nVIDIA Quadro FX540 V6.14.10.8198
Leadtek Quadro FX1400 128M (BIOS:V5.41.02.43.03)	PCIEX16_1	WinXP Pro. (CHT)	Pass	nVIDIA Quadro FX1400 V6.14.10.8421
NVS 280 (BIOS: V4.34.20.79.08)	PCIEX16_1	Win2000 Pro.	Pass	nVIDIA Quadro 280
NVS 285 (BIOS: V5.44.02.31.16)	PCIEX16_1	Win2000 Pro.	Pass	nVIDIA Quadro 285

Qualified PCI graphics cards

Model	Connect Interface	OS Environment	Status	Chipset/ Driver Version
ATI GC-R92SEPCI-C3 Rev.1.1 (BIOS: V8.011.006)	PCI1	WinXP Pro.	Pass	ATI Radeon 9200SE V8.241.0.0
Gecube R7000PCI-A3 Rev. 1.1 (BIOS: V008.004)	PCI1	WinXP Pro.	Pass	ATI Radeon 7000 V8.221.0.0

Qualified RAID cards

SATA disk controllers

Model	Connect Interface	OS Environment	Status	Chipset
Type: PCI				
PCIPromise SATAII 150 TX2 Plus (BIOS: V1.00.0.28)	PCI1	WinXP Pro.	Pass	Promise PDC20575
Promise SATAII 150 TX4 (BIOS: V1.00.0.28)	PCI1	WinXP Pro. (CHT)	Pass	Promise PDC40518

SATA RAID controllers

Model	Connect Interface	OS Environment	Status	Chipset
Type: PCI				
Promise FastTrak S150 SX4-M (BIOS: V2.0.00.21)	PCI1	Win2003-64 Standard R2	Pass	Promise PDC20621
Promise FastTrak S150 TX4 (BIOS: V1.00.0.37)	PCI2	Win2000 Pro. (CHT)	Pass	Promise PDC20319
Promise FastTrak TX4200 (BIOS: V2.00.0.23)	PCI1	WinXP Pro. (CHT)	Pass	Promise PDC40519
Type: PCI-X				
Adaptec AAR2410SA (BIOS: V4.2-0)	PCIX_1	Win2003 R2 Standard(CHS)	Pass	Adaptec 2410SA

SCSI disk controller

Model	Connect Interface	OS Environment	Status	Chipset
Type: PCI-X				
ASUS PXL-S30 Rev.1.04 (BIOS:V5.07.03)	PCIX_2	WinXP Pro. (CHT)	Pass	LSI LS153C1030

SCSI RAID controllers

Model	Connect Interface	OS Environment	Status	Chipset
Type: PCIEX8				
Intel SRCU42E Ultra320 (BIOS: H420)	PCIEX16_2	Win2003 R2 Standard(CHS)	Pass	Intel 80332
Type: PCI-X				
Intel SRCU42L (BIOS: V2.34.05-Ro43)	PCI2, PCIX_2	WinXP Pro.	Pass	GC80303

IDE RAID controllers

Model	Connect Interface	OS Environment	Status	Chipset
Type: PCI				
Adaptec 1200A Rev.A (BIOS: V1.3)	PCI1	WinXP Pro. (CHT)	Pass	HighPoint HPT370

2.6 Jumpers

1. Clear RTC RAM (CLRTC)

This jumper allows you to clear the Real Time Clock (RTC) RAM in CMOS. You can clear the CMOS memory of date, time, and system setup parameters by erasing the CMOS RTC RAM data. The onboard button cell battery powers the RAM data in CMOS, which include system setup information such as system passwords.

To erase the RTC RAM:

1. Turn OFF the computer and unplug the power cord.
2. Remove the onboard battery.
3. Move the jumper cap from pins 1-2 (default) to pins 2-3. Keep the cap on pins 2-3 for about 5~10 seconds, then move the cap back to pins 1-2.
4. Reinstall the battery.
5. Plug the power cord and turn ON the computer.
6. Hold down the key during the boot process and enter BIOS setup to re-enter data.



Except when clearing the RTC RAM, never remove the cap on CLRTC jumper default position. Removing the cap will cause system boot failure!

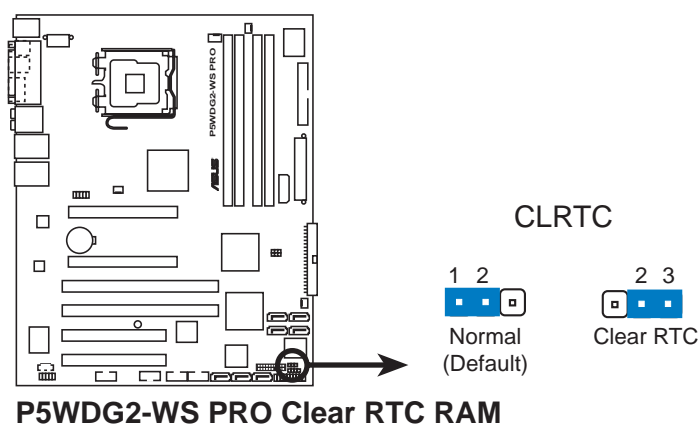

You do not need to clear the RTC when the system hangs due to overclocking. For system failure due to overclocking, use the C.P.R. (CPU Parameter Recall) feature. Shut down and reboot the system so the BIOS can automatically reset parameter settings to default values.

2. PCI-X Speed setting (6-pin PCIX_SPEED)

This jumper allows you to set the PCI-X slots' maximum frequency capability.

Default setting [Auto]: a single PCI-X card installed on a PCI-X slot can provide 133 MHz capability, and two PCI-X cards installed on both PCI-X slots can provide 100 MHz capability for reliability.

3~4: the slots will have 133 MHz capability whether you install one or two cards.

5~6: the slots will have 100 MHz capability whether you install one or two cards.

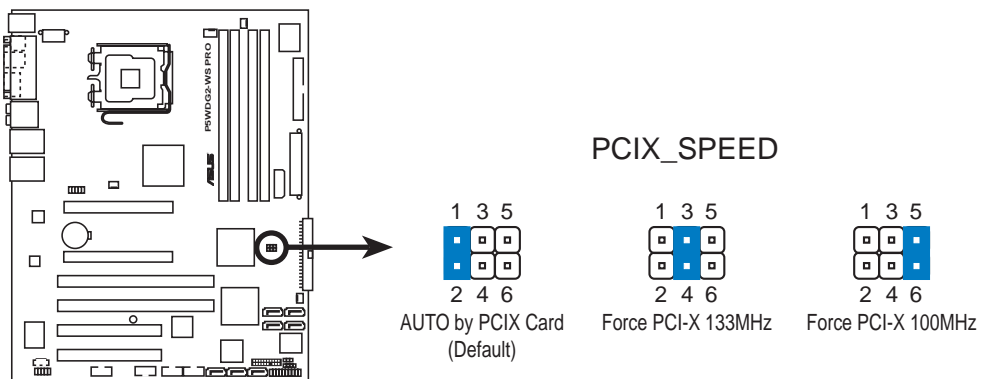

P5WDG2-WS PRO PCIX Speed setting

2.7 Connectors

2.7.1 Rear panel connectors

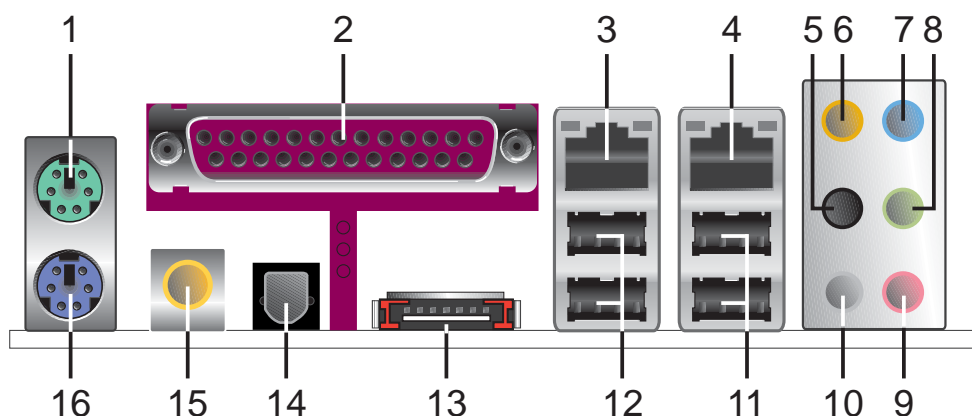

1. **PS/2 mouse port (green).** This port is for a PS/2 mouse.
2. **Parallel port.** This 25-pin port connects a parallel printer, a scanner, or other devices.
3. **LAN1 (RJ-45) port.** This Marvell® LAN port allows Gigabit connection to a Local Area Network (LAN) through a network hub. Refer to the table below for the LAN port LED indications.
4. **LAN2 (RJ-45) port.** This Marvell® LAN port allows Gigabit connection to a Local Area Network (LAN) through a network hub. Refer to the table below for the LAN port LED indications.

32-bit OS LAN port LED indications

Activity/Link	Speed LED	Description
OFF	OFF	Soft-off Mode
YELLOW*	OFF	10 Mbps connection
YELLOW*	ORANGE	100 Mbps connection
YELLOW*	GREEN	1 Gbps connection

* Blinking

64-bit OS LAN port LED indications

Activity/Link	Speed LED	Description
DNR	DNR	Soft-off Mode
DNR	DNR	10 Mbps connection
DNR	DNR	100 Mbps connection
DNR	DNR	1 Gbps connection

DNR - Driver Not Ready



Item numbers 9, 10, and 11 are only for the optional Wireless LAN module.

5. **Rear Speaker Out port (black).** This port connects the rear speakers on a 4-channel, 6-channel, or 8-channel audio configuration.
6. **Center/Subwoofer port (orange).** This port connects the center/subwoofer speakers.
7. **Line In port (light blue).** This port connects a tape, CD, DVD player, or other audio sources.
8. **Line Out port (lime).** This port connects a headphone or a speaker. In 4-channel, 6-channel, and 8-channel configuration, the function of this port becomes Front Speaker Out.



Refer to the audio configuration table below for the function of the audio ports in 2, 4, 6, or 8-channel configuration.

Audio 2, 4, 6, or 8-channel configuration

Port	Headset 2-channel	4-channel	6-channel	8-channel
Light Blue	Line In	Line In	Line In	Line In
Lime	Line Out	Front Speaker Out	Front Speaker Out	Front Speaker Out
Pink	Mic In	Mic In	Mic In	Mic In
Black	–	Rear Speaker Out	Rear Speaker Out	Rear Speaker Out
Gray	–	–	–	Side Speaker Out
Orange	–	–	Center/Subwoofer	Center/Subwoofer

9. **Microphone port (pink).** This port connects a microphone.
10. **Side Speaker Out port (gray).** This port connects the side speakers in an 8-channel audio configuration.
11. **USB 2.0 ports 3 and 4.** These two 4-pin Universal Serial Bus (USB) ports are available for connecting USB 2.0 devices.
12. **USB 2.0 ports 1 and 2.** These two 4-pin Universal Serial Bus (USB) ports are available for connecting USB 2.0 devices.

13. External SATA port. This port connects to an external SATA box or a Serial ATA port multiplier.



The external SATA port supports external Serial ATA 1.5 and 3 Gb/s devices. Longer cables support higher power requirements to deliver signal up to two meters away, and enables improved hot-swap function.



Do not insert a different connector to this port.

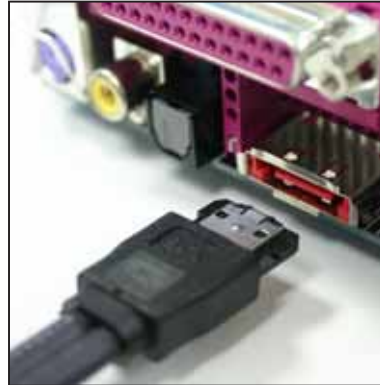

14. Optical S/PDIF Out port. This port connects an external audio output device via an optical S/PDIF cable.

15. Coaxial S/PDIF Out port. This port connects an external audio output device via a coaxial S/PDIF cable.

16. PS/2 keyboard port (purple). This port is for a PS/2 keyboard.

2.7.2 Internal connectors

1. Floppy disk drive connector (34-1 pin FLOPPY)

This connector is for the provided floppy disk drive (FDD) signal cable. Insert one end of the cable to this connector, then connect the other end to the signal connector at the back of the floppy disk drive.



Pin 5 on the connector is removed to prevent incorrect cable connection when using a FDD cable with a covered Pin 5.

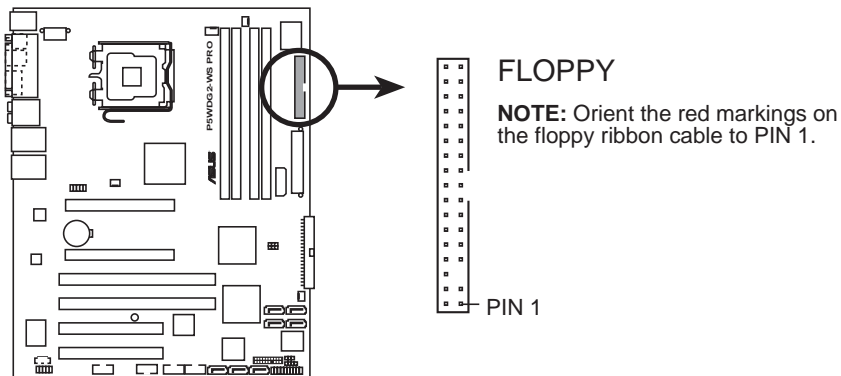

P5WDG2-WS PRO Floppy disk drive connector

2. Primary IDE connector (40-1 pin PRI_IDE)

The onboard IDE connector is for the Ultra DMA (133/100/66) signal cable. There are three connectors on each Ultra DMA 133/100/66 signal cable: blue, black, and gray. Connect the blue connector to the motherboard's IDE connector, then select one of the following modes to configure your device.

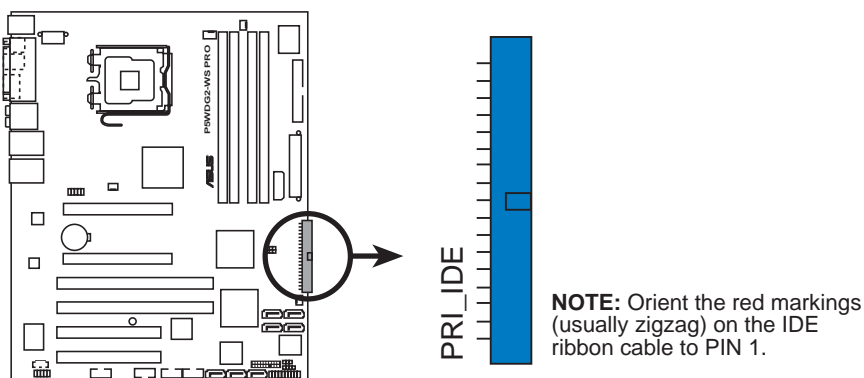

P5WDG2-WS PRO IDE connector



- Pin 20 on the IDE connector is removed to match the covered hole on the Ultra DMA cable connector. This prevents incorrect insertion when you connect the IDE cable.
- Use the 80-conductor IDE cable for Ultra DMA 100/66 IDE devices.

	Drive jumper setting	Mode of device(s)	Cable connector
Single device	Cable-Select or Master	-	Black
Two devices	Cable-Select	Master	Black
		Slave	Gray
	Master	Master	Black or gray
		Slave	



If any device jumper is set as "Cable-Select," make sure all other device jumpers have the same setting.

3. ICH7R Serial ATA connectors (7-pin SATA1 [red], SATA2 [red], SATA3 [black], SATA4 [black])

These connectors are for Serial ATA signal cables for Serial ATA hard disk drives.

If you installed Serial ATA hard disk drives, you can create a RAID 0, RAID 1, RAID 10, and RAID 5 configuration with the Intel® Matrix Storage Technology through the onboard Intel® ICH7R RAID controller.



- These connectors are set to **Standard IDE** mode by default. In **Standard IDE** mode, you can connect Serial ATA boot/data hard disk drives to these connectors. If you intend to create a Serial ATA RAID set using these connectors, set the **Configure SATA As** item in the BIOS to [RAID]. See section "4.3.6 IDE Configuration" for details.
- For RAID 5, use at least three hard disk drives. For RAID 10, use at least four hard disk drives. Use two to four Serial ATA hard disk drives for each RAID 0 or RAID 1 set.

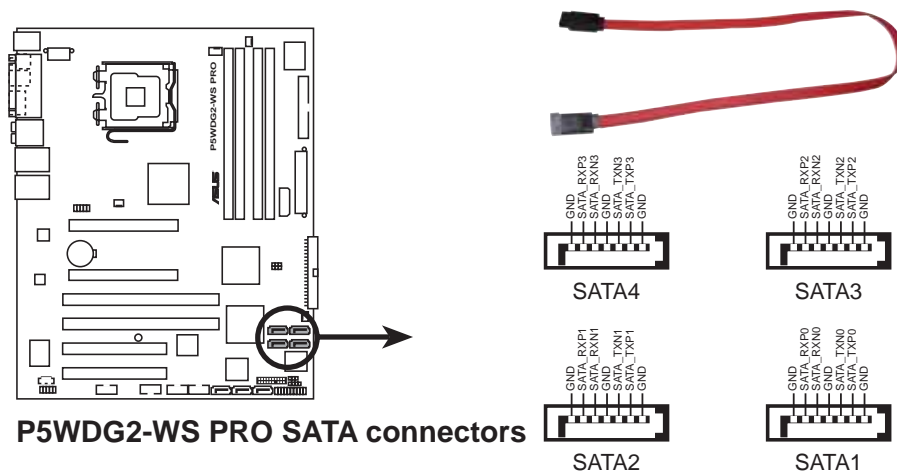



Important notes on Serial ATA

- You must install Windows® 2000 Service Pack 4 or the Windows® XP Service Pack 1 before using Serial ATA hard disk drives. The Serial ATA RAID feature (RAID 0/RAID 1/RAID 5/RAID 10) is available only if you are using Windows® 2000/XP/Server 2003 or later version.
- When using the connectors in **Standard IDE** mode, connect the primary (boot) hard disk drive to the SATA1 or SATA2 connector. Refer to the table below for the recommended SATA hard disk drive connections.

Serial ATA hard disk drive connection

Connector	Color	Setting	Use
SATA1/SATA2	Red	Master	Boot disk
SATA3/SATA4	Black	Slave	Data disk

4. Marvell® 88SE614x Serial ATA connectors (7-pin EXT_SATA1, EXT_SATA2, EXT_SATA3)

These connectors are for Serial ATA signal cables. These connectors support Serial ATA hard disk drives.



Set the **Marvell SATA Controller** and **Marvell SATA BOOTROM** items in the BIOS to [Enabled] to use the connectors to build a RAID set. See section “4.4.6 Onboard Devices Configuration” for details.

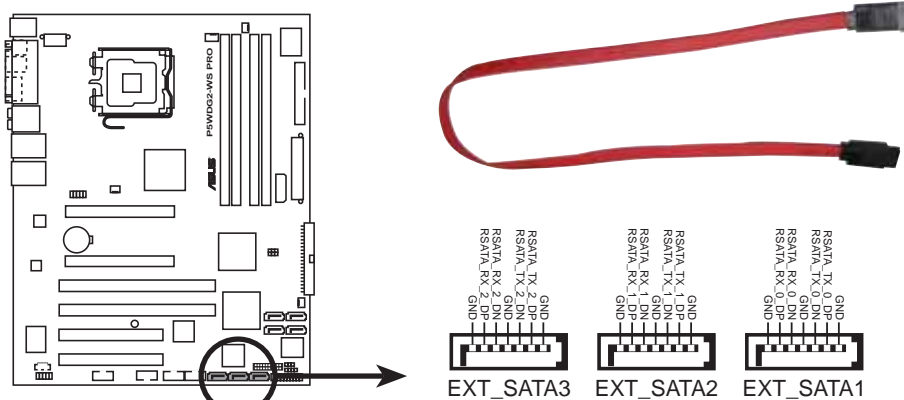

P5WDG2-WS PRO SATA 3 Gbps connector



Before creating a RAID set using Serial ATA hard disks, make sure that you have connected the Serial ATA signal cables and installed Serial ATA hard disk drives; otherwise, you cannot enter the Marvell® 88SE6141 RAID utility.

5. Optical drive audio connector (4-pin CD)

This connector is for the 4-pin audio cable that connects to the audio connector at the back of the optical drive.

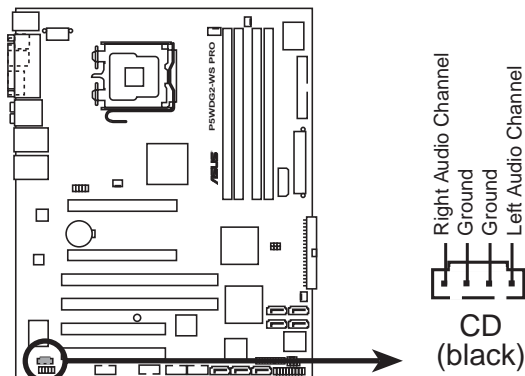

P5WDG2-WS PRO Internal audio connector

6. Front panel audio connector (10-1 pin AAFP)

This connector is for a chassis-mounted front panel audio I/O module that supports either HD Audio or legacy AC'97 audio standard.

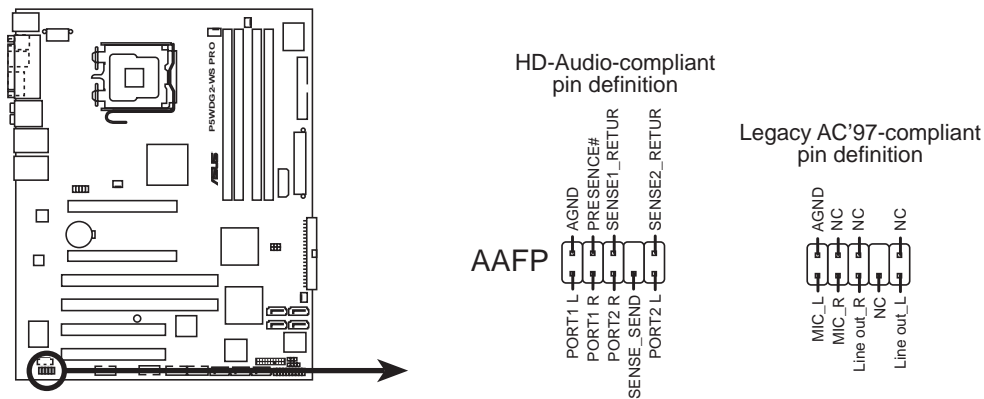

P5WDG2-WS PRO Front panel audio connector



- We recommend that you connect a high-definition front panel audio module to this connector to avail of the motherboard's High Definition Audio capability.

7. USB connectors (10-1 pin USB56, USB78)

These connectors are for USB 2.0 ports. Connect the USB module cable to any of these connectors, then install the module to a slot opening at the back of the system chassis. These USB connectors comply with USB 2.0 specification that supports up to 480 Mbps connection speed.

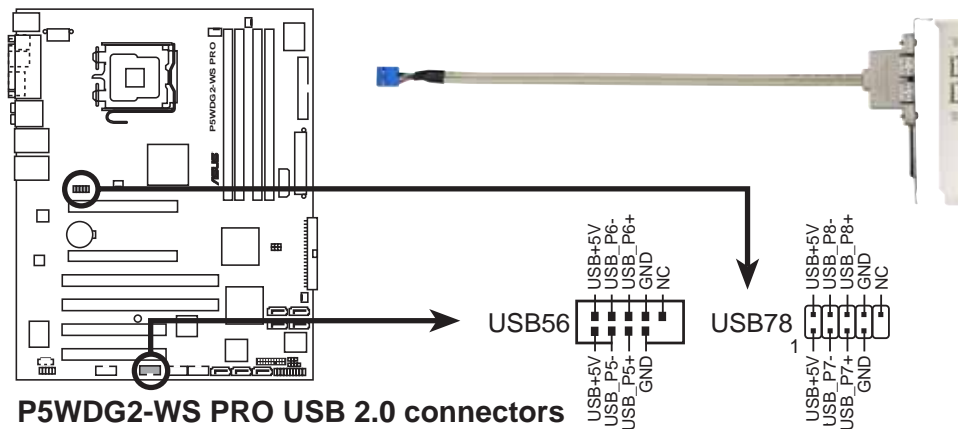

Never connect a **1394 cable** to the USB connectors. Doing so will damage the motherboard!

8. IEEE 1394a port connectors (10-1 pin IE1394_1; 10-1 pin IE1394_2)

These connectors are for additional IEEE 1394a ports. Connect the IEEE 1394a module cables to any of these connectors, then install the module to a slot opening at the back of the system chassis.

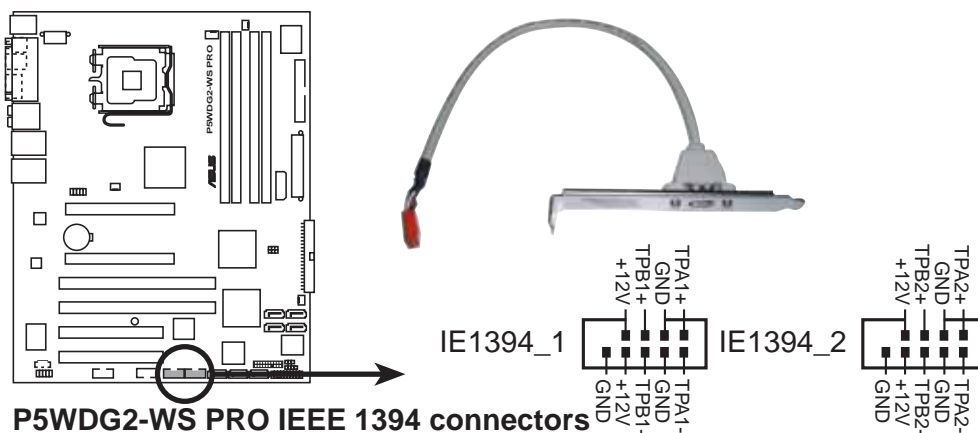

Never connect a **USB port module cable** to the IEEE 1394 connector. Doing so will damage the motherboard!

9. Chassis intrusion connector (4-1 pin CHASSIS)

This connector is for a chassis-mounted intrusion detection sensor or switch. Connect one end of the chassis intrusion sensor or switch cable to this connector. The chassis intrusion sensor or switch sends a high-level signal to this connector when a chassis component is removed or replaced. The signal is then generated as a chassis intrusion event.

By default, the pins labeled “Chassis Signal” and “Ground” are shorted with a jumper cap. Remove the jumper caps only when you intend to use the chassis intrusion detection feature.

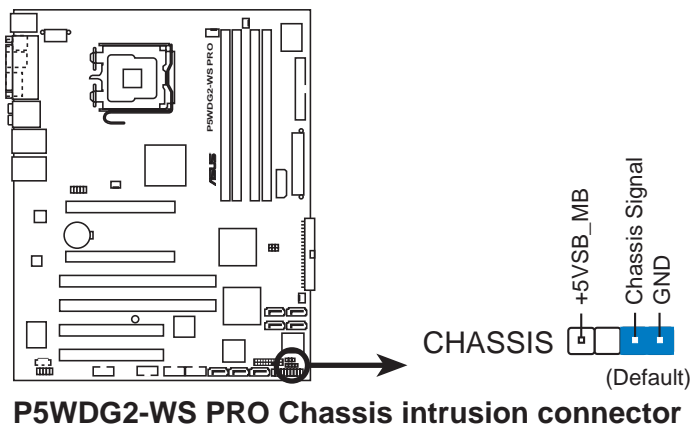

10. CPU, Chassis, and Power Fan connectors (4-pin CPU_FAN, 3-pin PWR_FAN, 3-pin CHA_FAN1, 3-pin CHA_FAN2)

The fan connectors support cooling fans of 350 mA ~ 2000 mA (24 W max.) or a total of 1 A ~ 3.48 A (41.76 W max.) at +12V. Connect the fan cables to the fan connectors on the motherboard, making sure that the black wire of each cable matches the ground pin of the connector.



Do not forget to connect the fan cables to the fan connectors. Insufficient air flow inside the system may damage the motherboard components. These are not jumpers! Do not place jumper caps on the fan connectors!

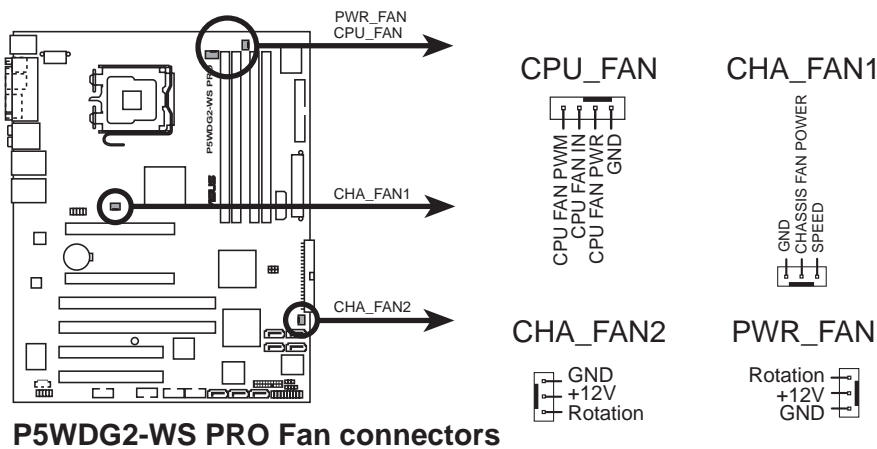

Only the CPU_FAN and CHA_FAN1 connectors support the ASUS Q-Fan 2 feature.



If you install two VGA cards, we recommend that you plug the rear chassis fan cable to the motherboard connector labeled CHA_FAN1 for better thermal environment.

11. Serial port connector (10-1 pin COM1)

This connector is for a serial (COM) port. Connect the serial port module cable to this connector, then install the module to a slot opening at the back of the system chassis.

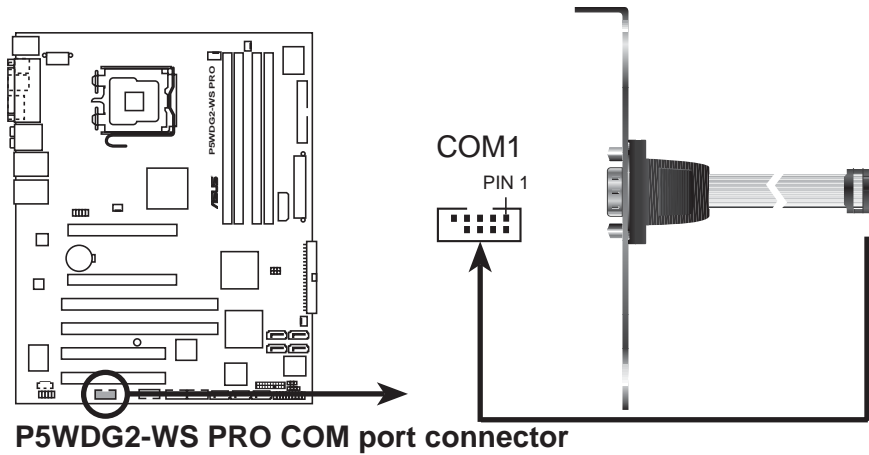

P5WDG2-WS PRO COM port connector

12. ATX power connectors (24-pin EATXPWR, 2x4-pin EATX12V)

These connectors are for ATX power supply plugs. The power supply plugs are designed to fit these connectors in only one orientation. Find the proper orientation and push down firmly until the connectors completely fit.

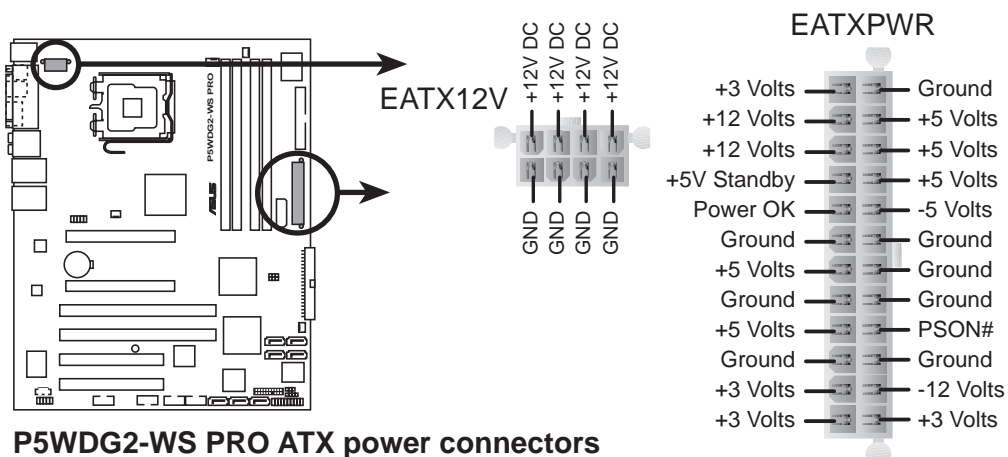

P5WDG2-WS PRO ATX power connectors



-
- You may use a 4-pin ATX12V power plug for this connector.
 - Make sure to remove the cap on the connector before connecting an 8-pin EPS +12V power plug.
 - Use only either a 4-pin ATX12V or an 8-pin EPS +12V power plug. Connecting other power plug types may cause serious damage to the system.
-

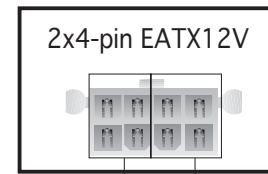

**Remove the cap
before using an
8-pin power plug**

**Connect a
4-pin power
plug here**



Important notes on motherboard power requirements

- For a fully configured system, we recommend that you use a power supply unit (PSU) that complies with ATX 12 V Specification 2.0 (or later version) and provides a minimum power of 400 W.
 - Do not forget to connect the 8-pin/4-pin EATX12 V power plug; otherwise, the system will not boot up.
 - Make sure that the PSU can support at least 8 A on the +12V_1 lead and 13 A on the +12V_2 lead.
 - Use of a PSU with a higher power output is recommended when configuring a system with more power consuming devices. The system may become unstable or may not boot up if the power is inadequate.
 - If you want to use two high-end PCI Express x16 graphics cards, use a PSU with 450 to 500 W power to ensure system stability.
 - To support an Intel® Dual-Core CPU up to 840 Extreme Edition, make sure that the PSU can provide at least DC 16A (peak 22A) on the +12V_2 lead.
-

13. TPM connector (20-1 pin TPM)

This connector supports a Trusted Platform Module (TPM) system, which can securely store keys, digital certificates, passwords, and data. A TPM system also helps enhance network security, protects digital identities, and ensures platform integrity.

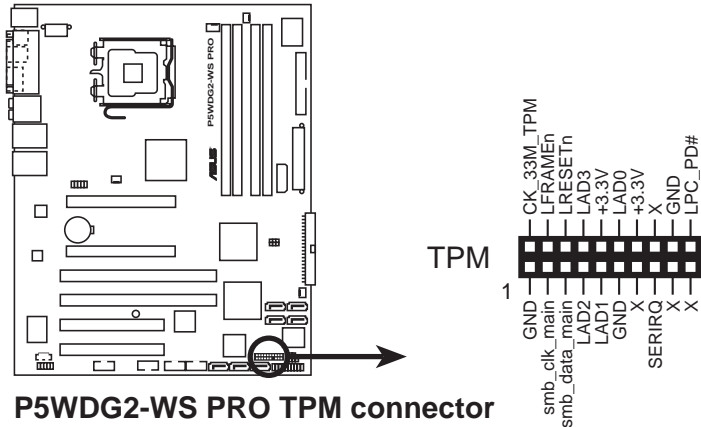

P5WDG2-WS PRO TPM connector



The TPM module is purchased separately.

14. System panel connector (12-pin PANEL)

This connector supports several chassis-mounted functions.

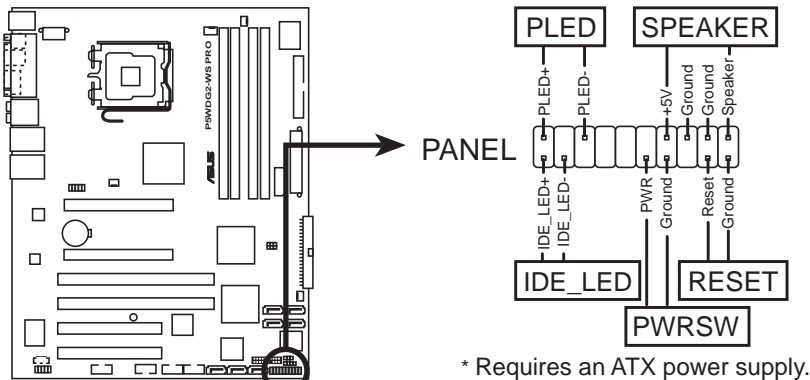

P5WDG2-WS PRO System panel connector



The system panel connector is color-coded for easy connection. Refer to the connector description below for details.

- **System power LED**
This 3-pin connector is for the system power LED. Connect the chassis power LED cable to this connector. The system power LED lights up when you turn on the system power, and blinks when the system is in sleep mode.
- **Hard disk drive activity LED**
This 2-pin connector is for the HDD Activity LED. Connect the HDD Activity LED cable to this connector. The IDE LED lights up or flashes when data is read from or written to the HDD.
- **System warning speaker**
This 4-pin connector is for the chassis-mounted system warning speaker. The speaker allows you to hear system beeps and warnings.
- **ATX power button/soft-off button**
This connector is for the system power button. Pressing the power button turns the system on or puts the system in sleep or soft-off mode depending on the BIOS settings. Pressing the power switch for more than four seconds while the system is ON turns the system OFF.
- **Reset button**
This 2-pin connector is for the chassis-mounted reset button for system reboot without turning off the system power.

This chapter describes the power up sequence, the vocal POST messages, and ways of shutting down the system.

Powering up

Chapter summary

3

3.1	Starting up for the first time	3-1
3.2	Turning off the computer	3-2

3.1 Starting up for the first time

1. After making all the connections, replace the system case cover.
2. Be sure that all switches are off.
3. Connect the power cord to the power connector at the back of the system chassis.
4. Connect the power cord to a power outlet that is equipped with a surge protector.
5. Turn on the devices in the following order:
 - a. Monitor
 - b. External SCSI devices (starting with the last device on the chain)
 - c. System power
6. After applying power, the system power LED on the system front panel case lights up. For systems with ATX power supplies, the system LED lights up when you press the ATX power button. If your monitor complies with “green” standards or if it has a “power standby” feature, the monitor LED may light up or switch between orange and green after the system LED turns on.

The system then runs the power-on self tests or POST. While the tests are running, the BIOS beeps (see BIOS beep codes table below) or additional messages appear on the screen. If you do not see anything within 30 seconds from the time you turned on the power, the system may have failed a power-on test. Check the jumper settings and connections or call your retailer for assistance.

AMI BIOS beep codes

Beep Description	Error
One beep	Keyboard controller error Refresh Time error No master drive detected
Two continuous beeps followed by two short beeps	Floppy controller failure
Two continuous beeps followed by four short beeps	Hardware component failure

7. At power on, hold down the <Delete> key to enter the BIOS Setup. Follow the instructions in Chapter 4.

3.2 Turning off the computer

3.2.1 Using the OS shut down function

If you are using Windows® 2000:

1. Click the **Start** button then click **Shut Down...**
2. Make sure that the **Shut Down** option button is selected, then click the **OK** button to shut down the computer.
3. The power supply should turn off after Windows® shuts down.

If you are using Windows® XP or later version:

1. Click the **Start** button then select **Turn Off Computer.**
2. Click the **Turn Off** button to shut down the computer.
3. The power supply should turn off after Windows® shuts down.

3.2.2 Using the dual function power switch

While the system is ON, pressing the power switch for less than four seconds puts the system to sleep mode or to soft-off mode, depending on the BIOS setting. Pressing the power switch for more than four seconds lets the system enter the soft-off mode regardless of the BIOS setting. Refer to section “4.5 Power Menu” in Chapter 4 for details.

This chapter tells how to change the system settings through the BIOS Setup menus. Detailed descriptions of the BIOS parameters are also provided.

BIOS setup



4.1	Managing and updating your BIOS	4-1
4.2	BIOS setup program	4-11
4.3	Main menu	4-14
4.4	Advanced menu	4-19
4.5	Power menu	4-32
4.6	Boot menu	4-37
4.7	Tools menu	4-44
4.8	Exit menu	4-47

4.1 Managing and updating your BIOS

The following utilities allow you to manage and update the motherboard Basic Input/Output System (BIOS) setup.

1. **ASUS Update** (Updates the BIOS in Windows® environment.)
2. **ASUS EZ Flash 2** (Updates the BIOS in DOS using a floppy disk or a USB flash disk.)
3. **ASUS AFUDOS** (Updates the BIOS in DOS mode using a bootable floppy disk.)
4. **ASUS CrashFree BIOS 3** (Updates the BIOS using a bootable floppy disk/USB flash disk, or the motherboard support CD when the BIOS file fails or gets corrupted.)

Refer to the corresponding sections for details on these utilities.



Save a copy of the original motherboard BIOS file to a bootable floppy disk in case you need to restore the BIOS in the future. Copy the original motherboard BIOS using the ASUS Update or AFUDOS utilities.

4.1.1 ASUS Update utility

The ASUS Update is a utility that allows you to manage, save, and update the motherboard BIOS in Windows® environment. The ASUS Update utility allows you to:

- Save the current BIOS file
- Download the latest BIOS file from the Internet
- Update the BIOS from an updated BIOS file
- Update the BIOS directly from the Internet, and
- View the BIOS version information.

This utility is available in the support CD that comes with the motherboard package.



ASUS Update requires an Internet connection either through a network or an Internet Service Provider (ISP).

Installing ASUS Update

To install ASUS Update:

1. Place the support CD in the optical drive. The **Drivers** menu appears.
2. Click the **Utilities** tab, then click **ASUS Update**. See page 5-3 for the **Utilities** screen menu.
3. The ASUS Update utility is copied to your system.



Quit all Windows® applications before you update the BIOS using this utility.

Updating the BIOS through the Internet

To update the BIOS through the Internet:

1. Launch the ASUS Update utility from the Windows® desktop by clicking **Start > Programs > ASUS > ASUSUpdate > ASUSUpdate**. The ASUS Update main window appears.

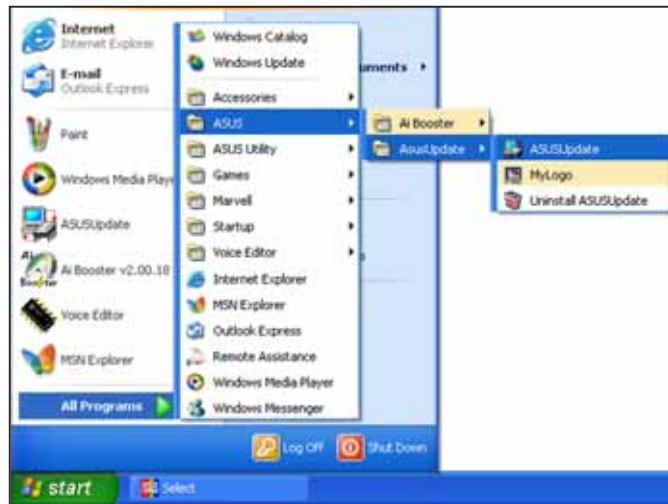

2. Select **Update BIOS from the Internet** option from the drop-down menu, then click **Next**.



3. Select the ASUS FTP site nearest you to avoid network traffic, or click **Auto Select**. Click **Next**.

4. From the FTP site, select the BIOS version that you wish to download. Click Next.
5. Follow the screen instructions to complete the update process.



The ASUS Update utility is capable of updating itself through the Internet. Always update the utility to avail of all its features.



Updating the BIOS through a BIOS file

To update the BIOS through a BIOS file:

1. Launch the ASUS Update utility from the Windows® desktop by clicking **Start > Programs > ASUS > ASUSUpdate > ASUSUpdate**. The ASUS Update main window appears.
2. Select **Update BIOS from a file** option from the drop-down menu, then click **Next**.



3. Locate the BIOS file from the **Open** window, then click **Save**.
4. Follow the screen instructions to complete the update process.

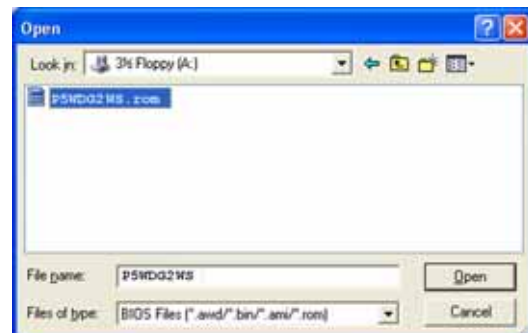

4.1.2 Creating a bootable floppy disk

1. Do either one of the following to create a bootable floppy disk.

DOS environment

- a. Insert a 1.44MB floppy disk into the drive.
- b. At the DOS prompt, type **format A:/S** then press <Enter>.

Windows® XP environment

- a. Insert a 1.44 MB floppy disk to the floppy disk drive.
- b. Click **Start** from the Windows® desktop, then select **My Computer**.
- c. Select the 3 1/2 Floppy Drive icon.
- d. Click **File** from the menu, then select **Format. A Format 3 1/2 Floppy Disk** window appears.
- e. **Windows® XP users:** Select **Create an MS-DOS startup disk** from the format options field, then click **Start**.

Windows® 2000 environment

To create a set of boot disks for Windows® 2000:

- a. Insert a formatted, high density 1.44 MB floppy disk into the drive.
 - b. Insert the Windows® 2000 CD to the optical drive.
 - c. Click **Start**, then select **Run**.
 - d. In the **Open** field, type **D:\bootdisk\makeboot a:** assuming that D is your optical drive letter.
 - e. Press <Enter>, then follow screen instructions to continue.
2. Copy the original or the latest motherboard BIOS file to the bootable floppy disk.

4.1.3 ASUS EZ Flash 2 utility

The ASUS EZ Flash 2 feature allows you to update the BIOS without having to go through the long process of booting from a floppy disk and using a DOS-based utility. The EZ Flash 2 utility is built in the BIOS chip so it is accessible by pressing <Alt> + <F2> during the Power-On Self Tests (POST).

To update the BIOS using EZ Flash 2:

1. Visit the ASUS website (www.asus.com) to download the latest BIOS file for the motherboard and rename the same to **WDG2WSP.ROM**.
2. Save the BIOS file to a floppy disk or a USB flash disk, then restart the system.
3. You can launch the EZ Flash 2 by two methods.
 - (1) Insert the floppy disk / USB flash disk that contains the BIOS file to the floppy disk drive or the USB port.

Press <Alt> + <F2> during POST to display the following.

```
ASUSTek EZ Flash 2 BIOS ROM Utility V3.00
FLASH TYPE: Winbond W39V080A 8Mb LPC

Current ROM          Update ROM
BOARD: P5WDG2-WS Pro  BOARD: Unknown
VER: 0204             VER: Unknown
DATE: 07/04/2006     DATE: Unknown

PATH: A:\
A:
[Note]
[Enter] Select      [S] Save           [ESC]Exit
[Tab] Switch        [Up/Down/Home/End] Move
```

- (2) Enter BIOS setup program. Go to the Tools menu to select EZ Flash 2 and press <Enter> to enable it.

You can switch between drives by pressing <Tab> before the correct file is found. Then press <Enter>.

4. When the correct BIOS file is found, EZ Flash 2 performs the BIOS update process and automatically reboots the system when done.



- This function can support devices such as USB flash disk, or floppy disk with FAT 32/16 format and single partition only.
- Do not shutdown or reset the system while updating the BIOS to prevent system boot failure!

4.1.4 AFUDOS utility

The AFUDOS utility allows you to update the BIOS file in DOS environment using a bootable floppy disk with the updated BIOS file. This utility also allows you to copy the current BIOS file that you can use as backup when the BIOS fails or gets corrupted during the updating process.

Copying the current BIOS

To copy the current BIOS file using the AFUDOS utility:



- Make sure that the floppy disk is not write-protected and has at least 1.2 MB free space to save the file.
- The succeeding BIOS screens are for reference only. The actual BIOS screen displays may not be same as shown.

1. Copy the AFUDOS utility (afudos.exe) from the motherboard support CD to the bootable floppy disk you created earlier.
2. Boot the system in DOS mode, then at the prompt type:

```
afudos /o[filename]
```

where the [filename] is any user-assigned filename not more than eight alphanumeric characters for the main filename and three alphanumeric characters for the extension name.

```
A:\>afudos /oOLDBIOS1.rom
```

Main filename Extension name

3. Press <Enter>. The utility copies the current BIOS file to the floppy disk.

```
A:\>afudos /oOLDBIOS1.rom
AMI Firmware Update Utility - Version 1.19(ASUS V2.07(03.11.24BB))
Copyright (C) 2002 American Megatrends, Inc. All rights reserved.
  Reading flash ..... done
  Write to file..... ok
A:\>
```

The utility returns to the DOS prompt after copying the current BIOS file.

Updating the BIOS file

To update the BIOS file using the AFUDOS utility:

1. Visit the ASUS website (www.asus.com) and download the latest BIOS file for the motherboard. Save the BIOS file to a bootable floppy disk.



Write the BIOS filename on a piece of paper. You need to type the exact BIOS filename at the DOS prompt.

2. Copy the AFUDOS utility (afudos.exe) from the motherboard support CD to the bootable floppy disk you created earlier.
3. Boot the system in DOS mode, then at the prompt type:

```
afudos /i[filename]
```

where [filename] is the latest or the original BIOS file on the bootable floppy disk.

```
A:\>afudos /iWDG2WSP.rom
```

4. The utility verifies the file and starts updating the BIOS.

```
A:\>afudos /iWDG2WSP.rom
AMI Firmware Update Utility - Version 1.19 (ASUS V2.07 (03.11.24BB))
Copyright (C) 2002 American Megatrends, Inc. All rights reserved.

WARNING!! Do not turn off power during flash BIOS
Reading file ..... done
Reading flash ..... done

Advance Check .....
Erasing flash ..... done
Writing flash ..... 0x0008CC00 (9%)
```



Do not shut down or reset the system while updating the BIOS to prevent system boot failure!

5. The utility returns to the DOS prompt after the BIOS update process is completed. Reboot the system from the hard disk drive.

```
A:\>afudos /iWDG2WSP.rom
AMI Firmware Update Utility - Version 1.19(ASUS V2.07(03.11.24BB))
Copyright (C) 2002 American Megatrends, Inc. All rights reserved.

WARNING!! Do not turn off power during flash BIOS
Reading file ..... done
Reading flash ..... done

Advance Check .....
Erasing flash ..... done
Writing flash ..... done
Verifying flash .... done

Please restart your computer

A:\>
```

4.1.5 ASUS CrashFree BIOS 3 utility

The ASUS CrashFree BIOS 3 is an auto recovery tool that allows you to restore the BIOS file when it fails or gets corrupted during the updating process. You can update a corrupted BIOS file using the motherboard support CD, the floppy disk, or the USB flash disk that contains the updated BIOS file.



Prepare the motherboard support CD or the floppy disk containing the updated motherboard BIOS before using this utility.

Recovering the BIOS from the support CD

To recover the BIOS from the support CD:

1. Turn on the system.
2. Insert the support CD to the optical drive.
3. The utility displays the following message and automatically checks the CD for the BIOS file.

```
Bad BIOS checksum. Starting BIOS recovery...
Checking for floppy...
```

When found, the utility reads the BIOS file and starts flashing the corrupted BIOS file.

```
Bad BIOS checksum. Starting BIOS recovery...
Checking for floppy...
Floppy not found!
Reading file "WDG2WSP.ROM". Completed.
Start flashing...
```

4. Restart the system after the utility completes the updating process.

Recovering the BIOS from a floppy/USB flash disk

To recover the BIOS from a floppy/USB flash disk:

1. Download the latest BIOS from the ASUS website (www.asus.com). Rename the BIOS file to **WDG2WSP.ROM**.
2. Insert the floppy/USB flash disk that contains the BIOS file to the FDD/USB port.
3. Turn on the system.

4. The utility automatically checks the devices for the BIOS file. When found, the utility reads the BIOS file and starts flashing the corrupted BIOS file.
5. Restart the system after the utility completes the updating process.



-
- Only the USB flash disk with FAT 32/16 format and single partition can support ASUS CrashFree BIOS 3. The device size should be smaller than 8 GB.
 - Flash time takes around one minute.
 - DO NOT shut down or reset the system while updating the BIOS! Doing so can cause system boot failure!
-

4.2 BIOS setup program

This motherboard supports a programmable firmware chip that you can update using the provided utility described in section “4.1 Managing and updating your BIOS.”

Use the BIOS Setup program when you are installing a motherboard, reconfiguring your system, or prompted to “Run Setup.” This section explains how to configure your system using this utility.

Even if you are not prompted to use the Setup program, you can change the configuration of your computer in the future. For example, you can enable the security password feature or change the power management settings. This requires you to reconfigure your system using the BIOS Setup program so that the computer can recognize these changes and record them in the CMOS RAM or the firmware hub.

The firmware hub on the motherboard stores the Setup utility. When you start up the computer, the system provides you with the opportunity to run this program. Press during the Power-On-Self-Test (POST) to enter the Setup utility; otherwise, POST continues with its test routines.

If you wish to enter Setup after POST, restart the system by pressing <Ctrl+Alt+Delete>, or by pressing the reset button on the system chassis. You can also restart by turning the system off and then back on. Do this last option only if the first two failed.

The Setup program is designed to make it as easy to use as possible. Being a menu-driven program, it lets you scroll through the various sub-menus and make your selections from the available options using the navigation keys.



-
- The default BIOS settings for this motherboard apply for most conditions to ensure optimum performance. If the system becomes unstable after changing any BIOS settings, load the default settings to ensure system compatibility and stability. Select the **Load Default Settings** item under the Exit Menu. See section “4.8 Exit Menu.”
 - The BIOS setup screens shown in this section are for reference purposes only, and may not exactly match what you see on your screen.
 - Visit the ASUS website (www.asus.com) to download the latest BIOS file for this motherboard.
-

4.2.1 BIOS menu screen

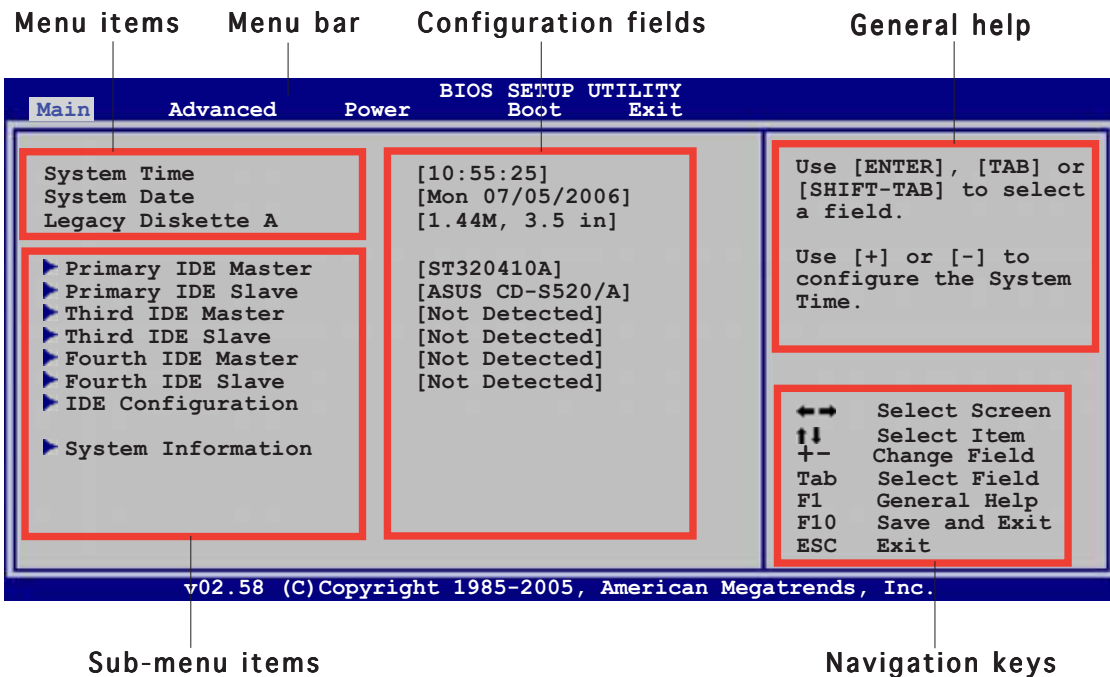

4.2.2 Menu bar

The menu bar on top of the screen has the following main items:

Main	For changing the basic system configuration
Advanced	For changing the advanced system settings
Power	For changing the advanced power management (APM) configuration
Boot	For changing the system boot configuration
Tools	For configuring options for special functions
Exit	For selecting the exit options and loading default settings

To select an item on the menu bar, press the right or left arrow key on the keyboard until the desired item is highlighted.

4.2.3 Navigation keys

At the bottom right corner of a menu screen are the navigation keys for that particular menu. Use the navigation keys to select items in the menu and change the settings.



Some of the navigation keys differ from one screen to another.

4.2.4 Menu items

The highlighted item on the menu bar displays the specific items for that menu. For example, selecting **Main** shows the Main menu items.

The other items (Advanced, Power, Boot, and Exit) on the menu bar have their respective menu items.

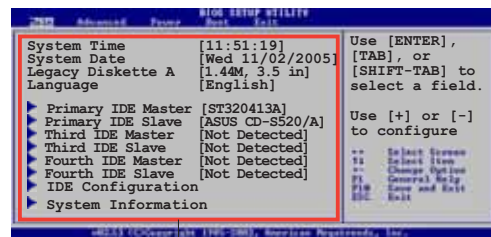

Main menu items

4.2.5 Sub-menu items

A solid triangle before each item on any menu screen means that the item has a sub-menu. To display the sub-menu, select the item and press <Enter>.

4.2.6 Configuration fields

These fields show the values for the menu items. If an item is user-configurable, you can change the value of the field opposite the item. You cannot select an item that is not user-configurable.

A configurable field is enclosed in brackets, and is highlighted when selected. To change the value of a field, select it then press <Enter> to display a list of options. Refer to “4.2.7 Pop-up window.”

4.2.7 Pop-up window

Select a menu item then press <Enter> to display a pop-up window with the configuration options for that item.

4.2.8 Scroll bar

A scroll bar appears on the right side of a menu screen when there are items that do not fit on the screen. Press the Up/Down arrow keys or <Page Up> / <Page Down> keys to display the other items on the screen.

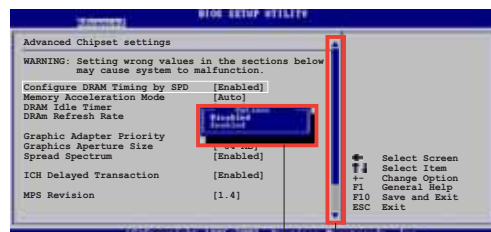

Pop-up window

Scroll bar

4.2.9 General help

At the top right corner of the menu screen is a brief description of the selected item.

4.3 Main menu

When you enter the BIOS Setup program, the **Main** menu screen appears, giving you an overview of the basic system information.



Refer to section “4.2.1 BIOS menu screen” for information on the menu screen items and how to navigate through them.

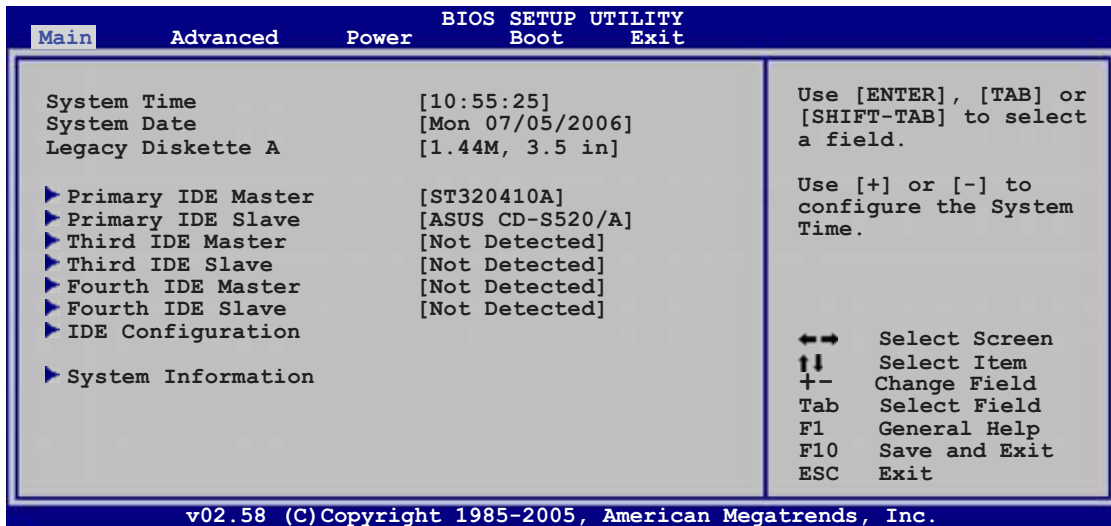

4.3.1 System Time [xx:xx:xx]

Allows you to set the system time.

4.3.2 System Date [Day xx/xx/xxxx]

Allows you to set the system date.

4.3.3 Legacy Diskette A [1.44M, 3.5 in.]

Sets the type of floppy drive installed. Configuration options: [Disabled] [360K, 5.25 in.] [1.2M, 5.25 in.] [720K, 3.5 in.] [1.44M, 3.5 in.] [2.88M, 3.5 in.]

4.3.4 Language [English]

Allows you to choose the BIOS language version from the options. Configuration options: [English] [Français] [Deutsch] [Japanese] [Chinese (GB)] [Chinese BIG5]

4.3.5 Primary, Third, and Fourth IDE Master/Slave

The BIOS automatically detects the connected IDE devices. There is a separate sub-menu for each IDE device. Select a device item, then press <Enter> to display the IDE device information.

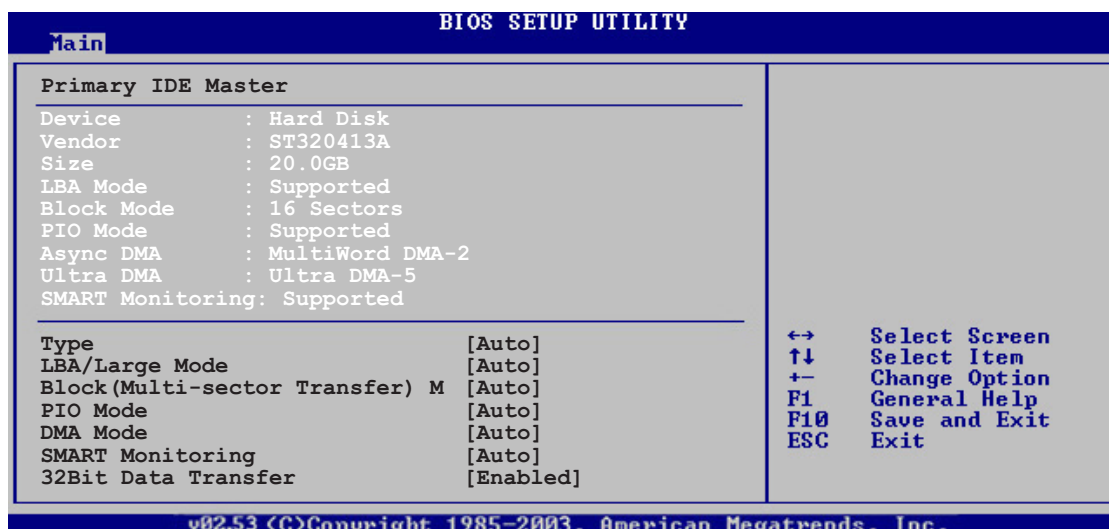

The BIOS automatically detects the values opposite the dimmed items (Device, Vendor, Size, LBA Mode, Block Mode, PIO Mode, Async DMA, Ultra DMA, and SMART monitoring). These values are not user-configurable. These items show N/A if no IDE device is installed in the system.

Type [Auto]

Selects the type of IDE drive. Setting to [Auto] allows automatic selection of the appropriate IDE device type. Select [CDROM] if you are specifically configuring a CD-ROM drive. Select [ARMD] (ATAPI Removable Media Device) if your device is either a ZIP, LS-120, or MO drive. Configuration options: [Not Installed] [Auto] [CDROM] [ARMD]

LBA/Large Mode [Auto]

Enables or disables the LBA mode. Setting to [Auto] enables the LBA mode if the device supports this mode, and if the device was not previously formatted with LBA mode disabled. Configuration options: [Disabled] [Auto]

Block (Multi-sector Transfer) M [Auto]

Enables or disables data multi-sector transfer mode. When set to [Auto], the data transfer from and to the device occurs multiple sectors at a time if the device supports multi-sector transfer feature. When set to [Disabled], the data transfer from and to the device occurs one sector at a time. Configuration options: [Disabled] [Auto]

PIO Mode [Auto]

Selects the PIO mode.

Configuration options: [Auto] [0] [1] [2] [3] [4]

DMA Mode [Auto]

Selects the DMA mode. Configuration options: [Auto]

SMART Monitoring [Auto]

Sets the Smart Monitoring, Analysis, and Reporting Technology.

Configuration options: [Auto] [Disabled] [Enabled]

32Bit Data Transfer [Enabled]

Enables or disables 32-bit data transfer.

Configuration options: [Disabled] [Enabled]

4.3.6 IDE Configuration

The items in this menu allow you to set or change the configurations for the IDE devices installed in the system. Select an item then press <Enter> if you want to configure the item.

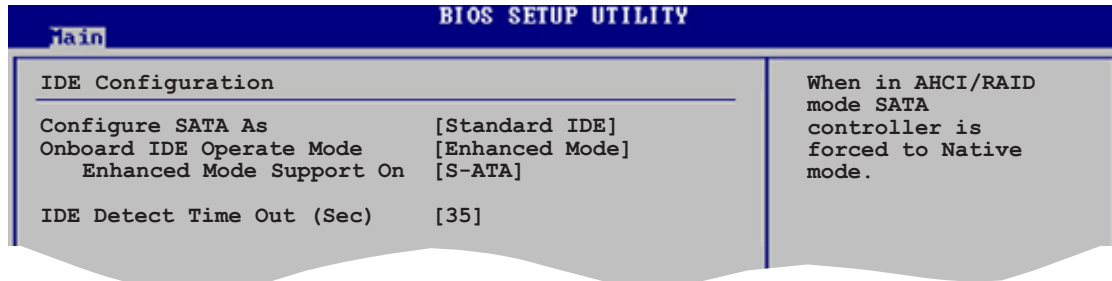

Configure SATA As [Standard IDE]

Sets the configuration for the Serial ATA connectors supported by the Southbridge chip.

The AHCI allows the onboard storage driver to enable advanced Serial ATA features that increases storage performance on random workloads by allowing the drive to internally optimize the order of commands.

If you want to create a RAID 0, RAID 1, RAID 10, and RAID 5, or the Intel® Matrix Storage Technology configuration from the Serial ATA hard disk drives, set this item to [RAID].

If you want to use the Serial ATA hard disk drives as Parallel ATA physical storage devices, keep the default setting [Standard IDE].

If you want the Serial ATA hard disk drives to use the Advanced Host Controller Interface (AHCI), set this item to [AHCI]. For details on AHCI, go to:
www.intel.com/support/chipsets/imst/sb/CS-012304.htm
www.intel.com/support/chipsets/imst/sb/CS-012305.htm

The SATA controller is set to Native mode when this item is set to [RAID] or [AHCI]



The **Onboard IDE Operate Mode** and its sub-menu items appear only when the **Configure SATA As** item is set to [Standard IDE].

Onboard IDE Operate Mode [Enhanced Mode]

Allows selection of the IDE operation mode depending on the installed operating system (OS). Set to [Enhanced Mode] if you are using OS supporting native mode, including Windows® 2000/XP. Configuration options: [Disabled] [Compatible Mode] [Enhanced Mode]



If you are using a Serial ATA optical drive, set this item to [Compatible Mode] before creating a boot disk using the support CD.

Enhanced Mode Support On [S-ATA]

Allows you to use **OS supporting native mode** on Serial ATA and Parallel ATA ports. It is recommend that you do not change the default setting for better OS compatibility. In this setting, you may use legacy OS on the Parallel ATA ports only if you do not install any Serial ATA device.

The P-ATA+S-ATA and P-ATA options are for advanced users only. If you set to any of these options and encountered problems, revert to the default setting **S-ATA**. Configuration options: [S-ATA+P-ATA] [S-ATA] [P-ATA]

Combined Mode Option [Primary P-ATA +S-ATA]

Allows you to choose the IDE ports to be used.
Configuration options: [Primary P-ATA +S-ATA] [S-ATA only] [P-ATA only]

The [S-ATA only] and [P-ATA only] options are for advanced users only. If you set to any of these options and encounter problems, revert to the default setting [Primary P-ATA+S-ATA].



The **Combined Mode Option** item appears when you set the **Onboard IDE Operate Mode** to [Compatible Mode].

Onboard Serial-ATA BOOTROOM [Enabled]

Enables or disables the onboard Serial ATA boot ROM.
Configuration options: [Disabled] [Enabled]



The **Onboard Serial-ATA BOOTROM** appears only when the **Configure SATA As** item is set to [RAID].

ALPE and ASP [Disabled]

Allows you to enable or disable the Aggressive Link Power Management (ALPE) and Aggressive Slumber/Partial (ASP) management features.
Configuration options: [Disabled] [Enabled]



The **ALPE and ASP** and its sub-menu item appear only when the **Configure SATA As** item is set to [AHCI].

IDE Detect Time Out(Sec) [35]

Selects the time out value for detecting ATA/ATAPI devices.
Configuration options: [0] [5] [10] [15] [20] [25] [30] [35]

4.3.7 System Information

This menu gives you an overview of the general system specifications. The BIOS automatically detects the items in this menu.

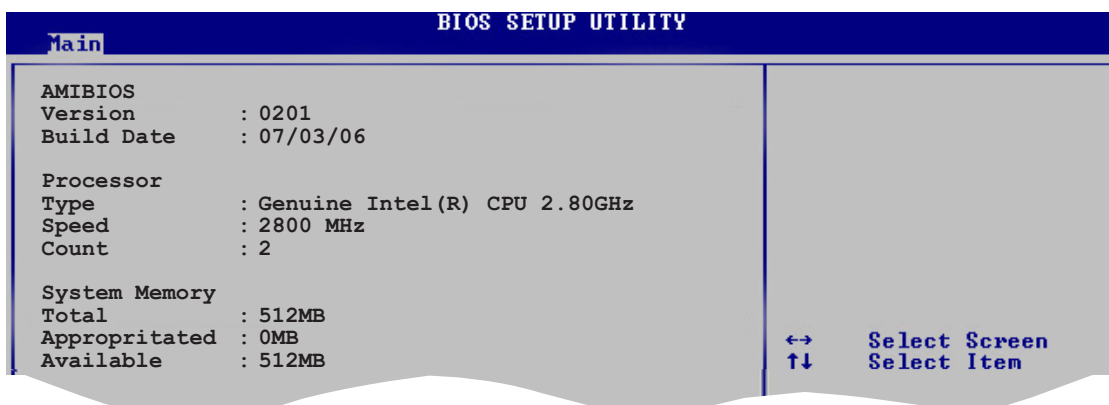

AMI BIOS

Displays the auto-detected BIOS information.

Processor

Displays the auto-detected CPU specification.

System Memory

Displays the auto-detected system memory.

4.4 Advanced menu

The Advanced menu items allow you to change the settings for the CPU and other system devices.



Take caution when changing the settings of the Advanced menu items. Incorrect field values can cause the system to malfunction.

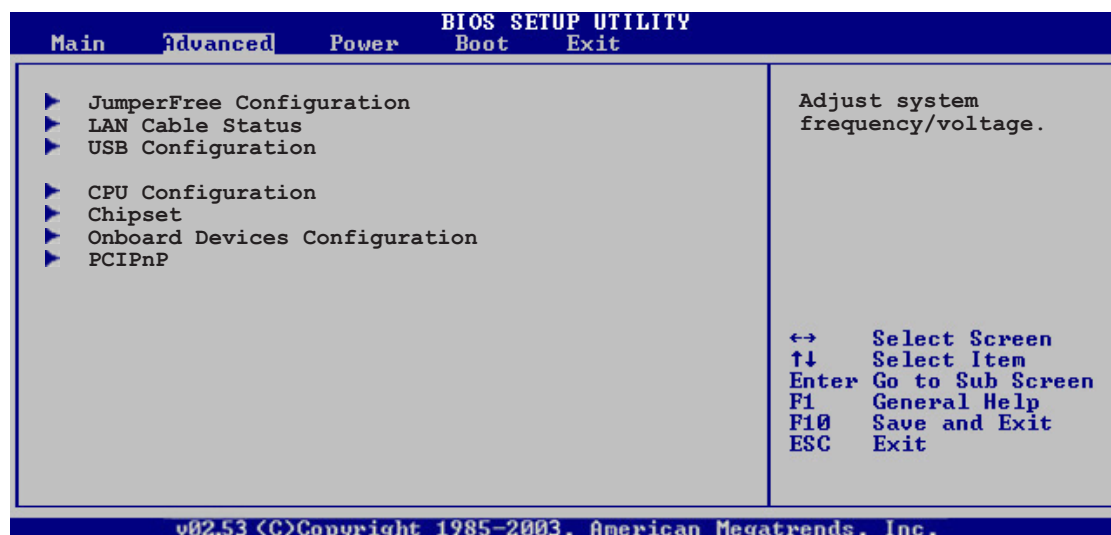

4.4.1 JumperFree Configuration

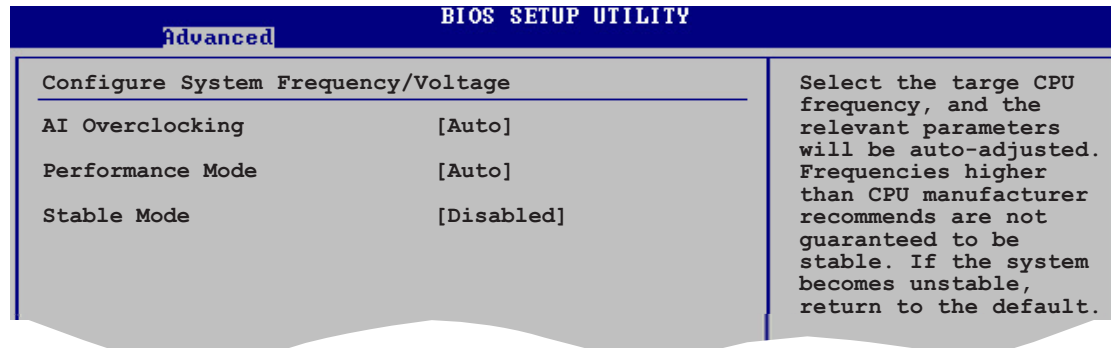

AI Overclocking [Auto]

Allows you to select the overclocking options to achieve the desired CPU internal frequency. Select either one of the preset overclocking configuration options.

Manual - allows you to individually set overclocking parameters.

Auto - loads the optimal settings for the system.

AI N.O.S. - the ASUS AI Non-delay Overclocking System feature intelligently determines the system load and automatically boost the performance for the most demanding tasks.

Overclock Profile - loads overclocking profiles with optimal parameters for stability when overclocking.



The following item appears only when you install a CPU that supports the lock free feature. Only some latest CPUs support this feature

CPU Lock Free [Auto]

This feature allows you to adjust the CPU multiplier to 14x. Setting this item to [Auto] allows the motherboard to automatically reduce the CPU multiplier value for more flexibility when increasing external FSB.

Configuration options: [Auto] [Disabled] [Enabled]



The following item appears only when you set the **AI Overclocking** item to [Manual].

CPU Frequency [XXX]

Displays the frequency sent by the clock generator to the system bus and PCI bus. The value of this item is auto-detected by the BIOS. Use the <+> and <-> keys to adjust the CPU frequency. You can also type the desired CPU frequency using the numeric keypad. The values range from 100 to 450.

DRAM Frequency [Auto]

Allows you to set the DDR operating frequency.

Configuration options: [Auto] [DDR2-400MHz] [DDR2-533MHz]
[DDR2-600MHz] [DDR2-667MHz] [DDR2-800MHz] [DDR2-889MHz]
[DDR2-1066MHz]



Selecting a very high DRAM frequency may cause the system to become unstable! If this happens, revert to the default setting.

Performance Mode [Auto]

Allows enhanced system performance. Setting to [Turbo] may cause the system to become unstable. If this happens, revert to the default setting [Auto]. Configuration options: [Auto] [Standard] [Turbo]

PCI Express Frequency [Auto]

Allows you to set the PCI Express frequency. This item is set to [Auto] by default. Configuration options: [Auto] [90] ~ [150]

PCI Clock Synchronization Mode [Auto]

Allows you to synchronize the PCI frequency with the PCI Express or CPU frequency. Configuration options: [To CPU] [33.33MHz] [Auto]

CPU Clock Spread Spectrum [Enabled]

Allows you to enable or disable the CPU clock spread spectrum. Configuration options: [Disabled] [Enabled]

PCIe Clock Spread Spectrum [Disabled]

Allows you to enable or disable the PCI Express clock spread spectrum. Configuration options: [Disabled] [Enabled]



The following items also appear when the **AI Overclocking** item is set to [AI NOS].

Memory Voltage [Auto]

Allows you to select the DDR2 reference voltage. Configuration options: [Auto] [1.80V] [1.90V] [1.95V] [2.00V] [2.05V] [2.10V] [2.15V] [2.20V] [2.25V] [2.30V] [2.35V] [2.40V]



Refer to the DDR2 documentation before adjusting the memory voltage. Setting a very high memory voltage may damage the memory module(s)!

CPU VCore Voltage [Auto]

Allows you to select the CPU VCore voltage. Configuration options: [Auto] [1.7000V] [1.6875V] [1.6750V] [1.6625V] [1.6500V] [1.6375V] [1.6250V] [1.6125V] [1.6000V] [1.5875V] [1.5750V] [1.5625V] [1.5500V] [1.5375V] [1.5250V] [1.5125V] [1.5000V] [1.4875V] [1.4750V] [1.4625V] [1.4500V] [1.4375V] [1.4250V] [1.4125V] [1.4000V] [1.3875V] [1.3750V] [1.3625V] [1.3500V] [1.3375V] [1.3250V] [1.3125V] [1.3000V] [1.2875V] [1.2750V] [1.2625V] [1.2500V] [1.2375V] [1.2250V] [1.2125V] [1.2000V]



Refer to the CPU documentation before setting the CPU Vcore voltage. Setting a high Vcore voltage may damage the CPU!

FSB Termination Voltage [Auto]

Allows you to select the front side bus termination voltage.
Configuration options: [Auto] [1.20V] [1.30V] [1.40V] [1.50V]



Setting a high FSB termination voltage may damage the chipset and CPU.

MCH Chipset Voltage [Auto]

Allows you to select the chipset voltage of the memory controller hub (MCH). Configuration options: [Auto] [1.50V] [1.60V] [1.70V] [1.80V]



Setting a high MCH chipset voltage may damage the chipset!

ICH Chipset Voltage [Auto]

Allows you to select the chipset voltage of the I/O controller hub (ICH).
Configuration options: [Auto] [1.05V] [1.20V]



Setting a high ICH chipset voltage may damage the chipset!



The following item appears only when the **AI Overclocking** item is set to [Overclock Profile].

Overclock Options [Overclock 5%]

Allows you to overclock the CPU speed through the available preset values.
Configuration options:

[Overclock 5%]	[FSB888/DDR2-667]
[Overclock 10%]	[FSB960/DDR2-800]
[Overclock 15%]	[FSB1200/DDR2-800]
[Overclock 20%]	[FSB1280/DDR2-800]
[Overclock 30%]	[FSB1333/DDR2-667]
	[FSB1333/DDR2-834]



The following item appears only when the **AI Overclocking** item is set to [AI NOS].

NOS Mode [Auto]

Sets the Non-Delay Overclocking System mode. Select either of the following configuration options:

Auto - loads the optimum sensitivity and overclocking percentage setting.

Manual - allows you to manually set overclocking configurations.



The following items appear if the **NOS Mode** item is set to [Manual]

Sensitivity [Sensitive]

Allows you to choose the sensitivity of the AI NOS sensor. Setting this item to [Sensitive] will trigger AI NOS with less CPU loading. Configuration options: [Normal] [Sensitive] [Less-Sensitive]

Target Frequency [Overclock XX%]

Allows you to set the maximum overclock percentage for the selected NOS Mode. Configuration options: [Overclock 3%] [Overclock 5%] [Overclock 7%] [Overclock 10%] [Overclock 15%] [Overclock 20%] [Overclock 30%]



Selecting a very high frequency may cause the system to become unstable. If this happens, revert to the default setting.

4.4.2 LAN Cable Status

This menu displays the status of the Local Area Network (LAN) cable connected to the LAN (RJ-45) port.

Advanced			BIOS SETUP UTILITY
POST Check LAN Cable [Disabled]			Check LAN cable during POST.
LAN Cable Status			
Pair	Status	Length	
1-2	N/A		
3-6	N/A		
4-5	N/A		
7-8	N/A		
1-2	N/A		
3-6	N/A		
4-5	N/A		
7-8	N/A		

©Copyright 1985-2002, American Megatrends, Inc.

POST Check LAN Cable [Disabled]

Allows you to enable or disable LAN cable check during POST. When enabled, the menu reports the cable faults or shorts, and displays the point (length) where the fault or short is detected.

Configuration options: [Disabled] [Enabled]



This function is available only on Marvell LAN (LAN2).

4.4.3 USB Configuration

The items in this menu allows you to change the USB-related features. Select an item then press <Enter> to display the configuration options.

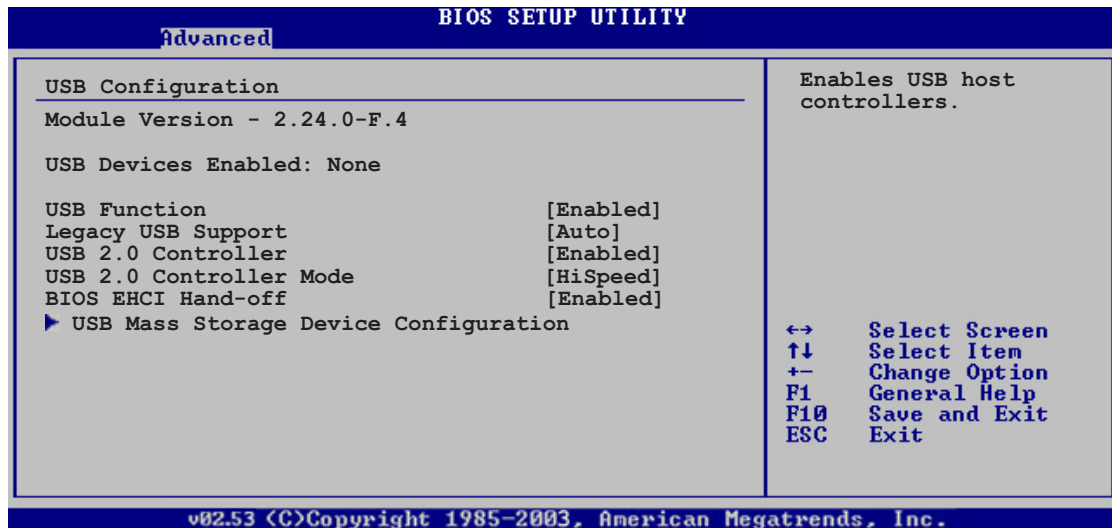

The **Module Version** and **USB Devices Enabled** items show the auto-detected values. If no USB device is detected, the item shows **None**.

USB Function [Enabled]

Enables or disables the USB host controllers.
Configuration options: [Disabled] [Enabled]

Legacy USB Support [Auto]

Allows you to enable or disable support for legacy USB devices. Setting to [Auto] allows the system to detect the presence of USB devices at startup. If detected, the USB controller legacy mode is enabled. If no USB device is detected, the legacy USB support is disabled.
Configuration options: [Disabled] [Enabled] [Auto]

USB 2.0 Controller [Enabled]

Allows you to enable or disable the USB 2.0 controller.
Configuration options: [Enabled] [Disabled]



The following items appear only when the **USB 2.0 Controller** is set to [Enabled].

USB 2.0 Controller Mode [HiSpeed]

Allows you to set the USB 2.0 controller mode to HiSpeed (480 Mbps) or FullSpeed (12 Mbps). Configuration options: [HiSpeed] [FullSpeed]

BIOS EHCI Hand-off [Enabled]

Allows you to enable support for operating systems without an EHCI hand-off feature. Configuration options: [Disabled] [Enabled]

Mass Storage Device Configuration

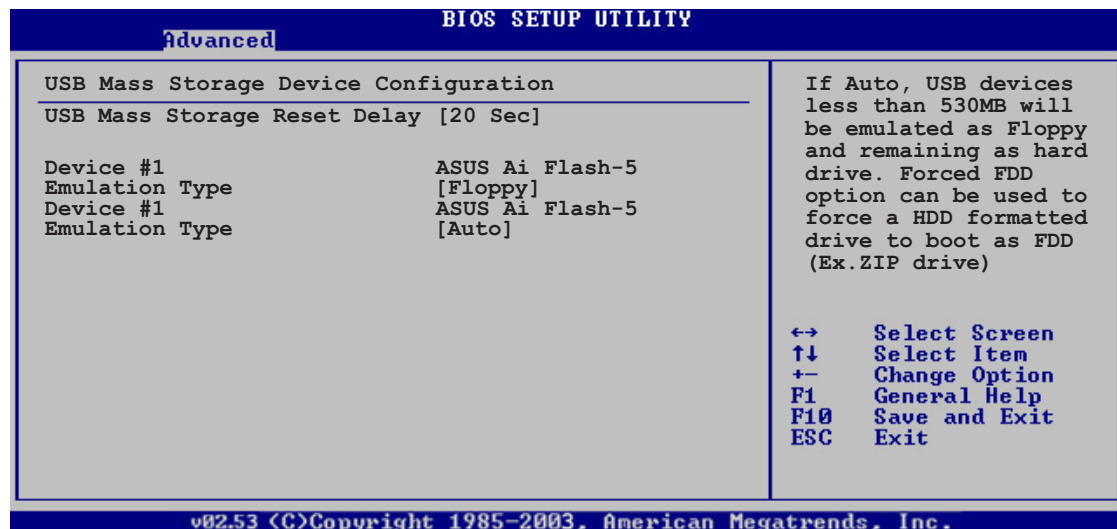

USB Mass Storage Reset Delay [20 Sec]

Configuration options: [10 Sec] [20 Sec] [30 Sec] [40 Sec]

Emulation Type [Floppy]

Sets the emulation type for the USB device. When set to Auto, USB devices less than 530 MB will be emulated as Floppy and the remaining as hard drive. Forced FDD option can be used to force a HDD formatted drive to boot as FDD (Ex. ZIP drive)

Configuration options: [Auto] [Floppy] [Forced FDD] [Hard Disk] [CDROM]

4.4.4 CPU Configuration

The items in this menu show the CPU-related information that the BIOS automatically detects.

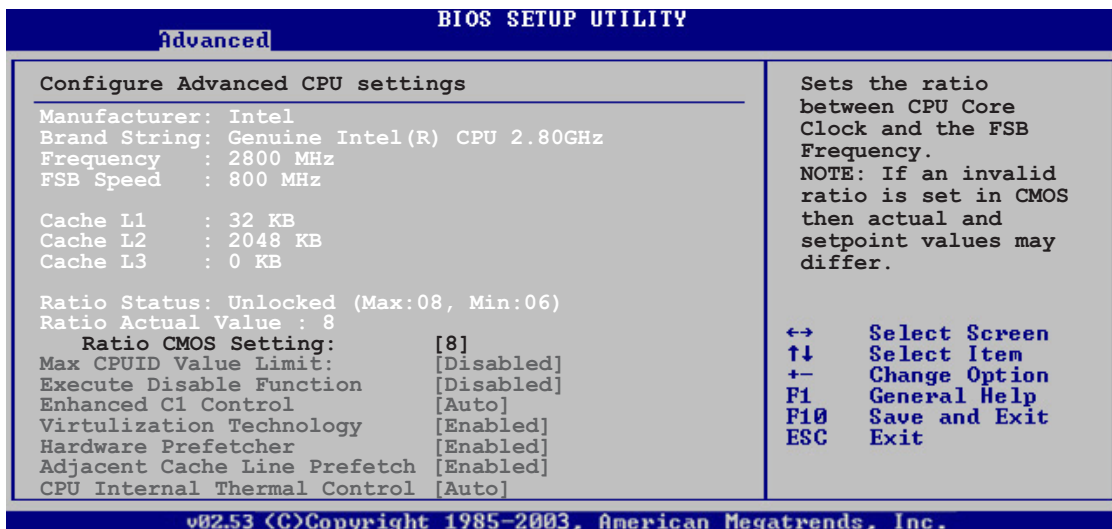

Ratio CMOS Setting [8]

Sets the ratio between the CPU core clock and the Front Side Bus frequency. The BIOS auto-detects the default value of this item. Use the <+> or <-> keys to adjust the values.



You can only adjust the **Ratio CMOS** if you installed an unlocked CPU. Refer to the CPU documentation for details.

Max CPUID Value Limit [Disabled]

Setting this item to [Enabled] allows legacy operating systems to boot even without support for CPUs with extended CPUID functions. Configuration options: [Disabled] [Enabled]

Execute Disable Function [Disabled]

Allows you to enable or disable the No-Execution Page Protection Technology. Setting this item to [Enabled] forces the XD feature flag to always return to zero (0). Configuration options: [Disabled] [Enabled]

Enhanced C1 Control [Auto]

Allows you to disable or set to auto the Enhanced C1 Control function. Configuration options: [Auto] [Disabled]

Virtualization Technology [Enabled]

Allows you to disable or enable the virtualization technology. Configuration options: [Enabled] [Disabled]

Hardware Prefetcher [Enabled]

Allows you to disable or enabled the hardward prefetcher function.
Configuration options: [Enabled] [Disabled]

Adjacent Cache Line Prefetch [Enabled]

Allows you to disable or enabled the Adjacent Cache Line Prefetch function. Configuration options: [Enabled] [Disabled]

CPU Internal Thermal Control [Auto]

Allows you to disable or set to auto the CPU Internal Thermal Control function. When set to [Auto], the BIOS automatically checks the CPU's capability to enable TM or TM2 support. In TM mode, the CPU power consumption is reduced. In TM2 mode, the CPU core and VID are reduced. Configuration options: [Auto] [Disabled]

Scroll down the screen to display the following item.



The following item appears only when you installed an Intel® Pentium® 4 CPU that supports the Enhanced Intel SpeedStep® Technology (EIST).

Intel(R) SpeedStep Technology [Disabled]

Allows you to use the Enhanced Intel SpeedStep® Technology. When set to [Automatic], you can adjust the system power settings in the operating system to use the EIST feature.

Set this item to [Disabled] if you do not want to use the EIST.

Configuration options: [Minimum Speed] [Automatic] [Disabled]



-
- Refer to the Appendix for details on how to use the EIST feature.
 - The motherboard comes with a BIOS file that supports EIST.
-

4.4.5 Chipset

The Chipset menu allows you to change the advanced chipset settings. Select an item then press <Enter> to display the sub-menu.

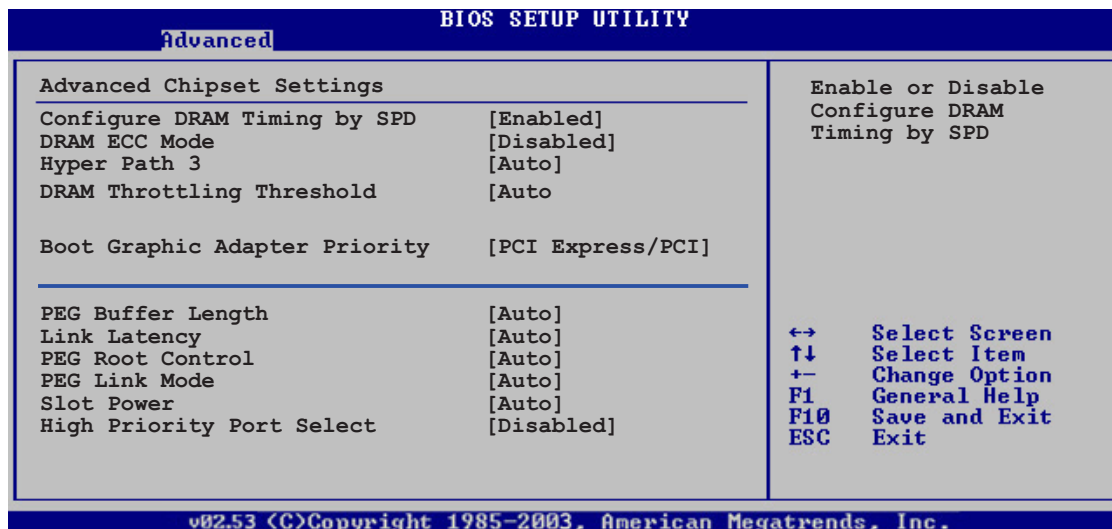

Configure DRAM Timing by SPD [Enabled]

When this item is enabled, the DRAM timing parameters are set according to the DRAM SPD (Serial Presence Detect). When disabled, you can manually set the DRAM timing parameters through the DRAM sub-items. The following sub-items appear when this item is Disabled. Configuration options: [Disabled] [Enabled]

DRAM CAS# Latency [5 Clocks]

Controls the latency between the SDRAM read command and the time the data actually becomes available. Configuration options: [6 Clocks] [5 Clocks] [4 Clocks] [3 Clocks]

DRAM RAS# Precharge [4 Clocks]

Controls the idle clocks after issuing a precharge command to the DDR SDRAM. Configuration options: [2 Clocks] ~ [6 Clocks]

DRAM RAS# to CAS# Delay [4 Clocks]

Controls the latency between the DDR SDRAM active command and the read/write command. Configuration options: [2 Clocks] ~ [6 Clocks]

DRAM RAS# Activate to Precharge Delay [15 Clocks]

Configuration options: [4 Clocks] ~ [18 Clocks]

DRAM Write Recovery Time [4 Clocks]

Configuration options: [2 Clocks] ~ [6 Clocks]

DRAM ECC Mode [Disabled]

Allows you to disable or set to [Auto] the DRAM ECC mode. Configuration options: [Disabled] [Auto]

Hyper Path 3 [Auto]

Allows you to enable or disable the ASUS Hyper Path 3 feature.

Configuration options: [Disabled] [Enabled] [Auto]

DRAM Throttling Threshold [Auto]

Configuration options: [Disabled] [Auto]

Boot Graphic Adapter Priority [PCI Express/PCI]

Allows selection of the graphics controller to use as primary boot device.

Configuration options: [PCI Express/PCI] [PCI/PCI Express]

PEG Buffer Length [Auto]

Sets the length of the PCI Express graphics card buffer.

Configuration options: [Auto] [Long] [Short]

Link Latency [Auto]

Sets the PCI Express graphics card link latency.

Configuration options: [Auto] [Slow] [Normal]

PEG Root Control [Auto]

Allows you to enable, disable, or set to automatic the PCI Express graphics card root control. Configuration options: [Auto] [Disabled] [Enabled]

PEG Link Mode [Auto]

Sets the PCI Express graphics link mode. Setting this item to [Auto] allows the motherboard to automatically adjust the PCI Express graphics link mode to the correct frequency based on the system configuration. Four additional settings are available for overclocking the PEG Link Mode.

Configuration options: [Auto] [Slow] [Normal] [Fast] [Faster]

Slot Power [Auto]

Sets the PCI Express graphics card slot power.

Configuration options: [Auto] [Light] [Normal] [Heavy] [Heavier]

High Priority Port Select [Disabled]

Allows you to disable or select the high priority port. The specified high priority port will be given arbitration above VC0 but below VC1.

Configuration options: [Disabled] [PCI Express Port 1] [PCI Express Port 5] [PCI Express Port 6]

4.4.6 Onboard Devices Configuration

Advanced		BIOS SETUP UTILITY
Configure Win627EHG Super IO Chipset		Enable or disable High Definition Audio Controller.
HD Audio Controller	[Enabled]	
PCI-E Lan	[Enabled]	
PCI-E LAN PCI LAN BOOTROM	[Disabled]	
PCI Lan	[Enabled]	
PCI LAN BOOTROM	[Disabled]	
Marvell SATA Controller	[Enabled]	
Marvell SATA BOOTROM	[Disabled]	
Onboard 1394 Controller	[Enabled]	
Serial Port1 Address	[3F8/IRQ4]	
Parallel Port Address	[378]	
Parallel Port Mode	[ECP]	
ECP Mode DMA Channel	[DMA3]	
Parallel Port IRQ	[IRQ7]	

(C)Copyright 1985-2002, American Megatrends, Inc.

HD Audio Controller [Enabled]

Allows you to enable or disable the high-definition audio CODEC.
Configuration options: [Enabled] [Disabled]

PCI-E Lan [Enabled]

Allows you to enable or disable the PCI-E Lan.
Configuration options: [Enabled] [Disabled]

PCI-E LAN BOOTROM [Disabled]

Allows you to enable or disable the PCI-E boot ROM. Configuration options: [Disabled] [Enabled]

PCI Lan [Enabled]

Allows you to enable or disable the PCI Lan.
Configuration options: [Enabled] [Disabled]

PCI LAN BOOTROM [Disabled]

Allows you to enable or disable the PCI LAN boot ROM. Configuration options: [Disabled] [Enabled]

Marvell SATA Controller [Enabled]

Allows you to enable or disable the onboard Marvell® 88SE6141 Serial ATA controller. Configuration options: [Enabled] [Disabled]

Marvell SATA BOOTROM [Disabled]

Allows you to enable or disable the Marvell® 88SE6141 Serial ATA boot ROM. Configuration options: [Disabled] [Enabled]

Onboard 1394 Controller [Enabled]

Allows you to enable or disable the onboard IEEE 1394a controller.

Configuration options: [Enabled] [Disabled]

Serial Port1 Address [3F8/IRQ4]

Allows you to select the Serial Port1 base address.

Configuration options: [Disabled] [3F8/IRQ4] [2F8/IRQ3] [3E8/IRQ4] [2E8/IRQ3]

Parallel Port Address [378]

Allows you to select the Parallel Port base addresses.

Configuration options: [Disabled] [378] [278] [3BC]

Parallel Port Mode [ECP]

Allows you to select the Parallel Port mode.

Configuration options: [Normal] [Bi-directional] [EPP] [ECP]

ECP Mode DMA Channel [DMA3]

Appears only when the Parallel Port Mode is set to [ECP]. This item allows you to set the Parallel Port ECP DMA.

Configuration options: [DMA0] [DMA1] [DMA3]

EPP Version [1.9]

Appears only when the Parallel Port Mode is set to [EPP]. This item allows the BIOS to select the parallel port EPP version.

Configuration options: [DMA0] [DMA1] [DMA3]

Parallel Port IRQ [IRQ7]

Allows you to select the parallel port IRQ.

Configuration options: [IRQ5] [IRQ7]

4.4.7 PCI PnP

The PCI PnP menu items allow you to change the advanced settings for PCI/PnP devices. The menu includes setting IRQ and DMA channel resources for either PCI/PnP or legacy ISA devices, and setting the memory size block for legacy ISA devices.



Take caution when changing the settings of the PCI PnP menu items. Incorrect field values can cause the system to malfunction.

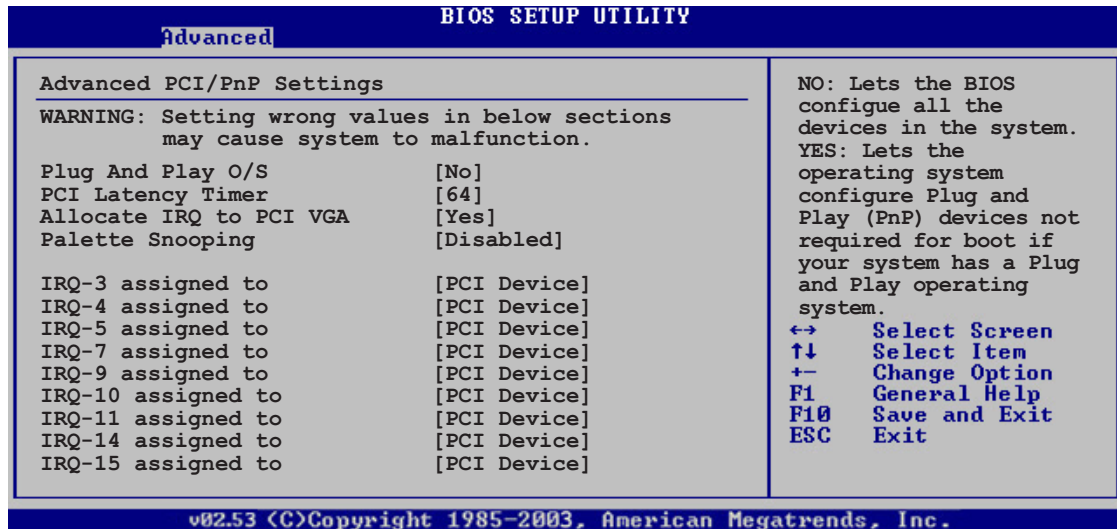

Plug And Play O/S [No]

When set to [No], BIOS configures all the devices in the system. When set to [Yes] and if you install a Plug and Play operating system, the operating system configures the Plug and Play devices not required for boot.

Configuration options: [No] [Yes]

PCI Latency Timer [64]

Allows you to select the value in units of PCI clocks for the PCI device latency timer register. Configuration options: [32] [64] [96] [128] [160] [192] [224] [248]

Allocate IRQ to PCI VGA [Yes]

When set to [Yes], BIOS assigns an IRQ to PCI VGA card if the card requests for an IRQ. When set to [No], BIOS does not assign an IRQ to the PCI VGA card even if requested. Configuration options: [No] [Yes]

Palette Snooping [Disabled]

When set to [Enabled], the palette snooping feature informs the PCI devices that an ISA graphics device is installed in the system so that the latter can function correctly. Configuration options: [Disabled] [Enabled]

IRQ-xx assigned to [PCI Device]

When set to [PCI Device], the specific IRQ is free for use of PCI/PnP devices. When set to [Reserved], the IRQ is reserved for legacy ISA devices. Configuration options: [PCI Device] [Reserved]

4.5 Power menu

The Power menu items allow you to change the settings for the ACPI and Advanced Power Management (APM) features. Select an item then press <Enter> to display the configuration options.

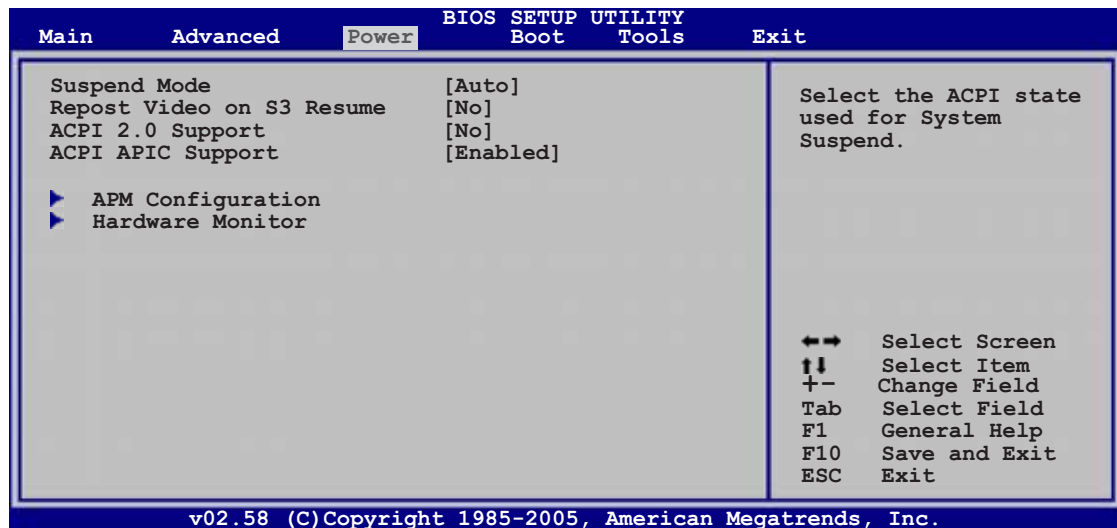

4.5.1 Suspend Mode [Auto]

Allows you to select the Advanced Configuration and Power Interface (ACPI) state to be used for system suspend. Setting this item to [Auto] allows the OS to select the ACPI state. Configuration options: [S1 (POS) only] [S3 only] [Auto]

4.5.2 Repost Video on S3 Resume [No]

Determines whether to invoke VGA BIOS POST on S3/STR resume. Configuration options: [No] [Yes]

4.5.3 ACPI 2.0 Support [No]

Allows you to add more tables for Advanced Configuration and Power Interface (ACPI) 2.0 specifications. Configuration options: [No] [Yes]

4.5.4 ACPI APIC Support [Enabled]

Allows you to enable or disable the Advanced Configuration and Power Interface (ACPI) support in the Advanced Programmable Interrupt Controller (APIC). When set to Enabled, the ACPI APIC table pointer is included in the RSDT pointer list. Configuration options: [Disabled] [Enabled]

4.5.5 APM Configuration

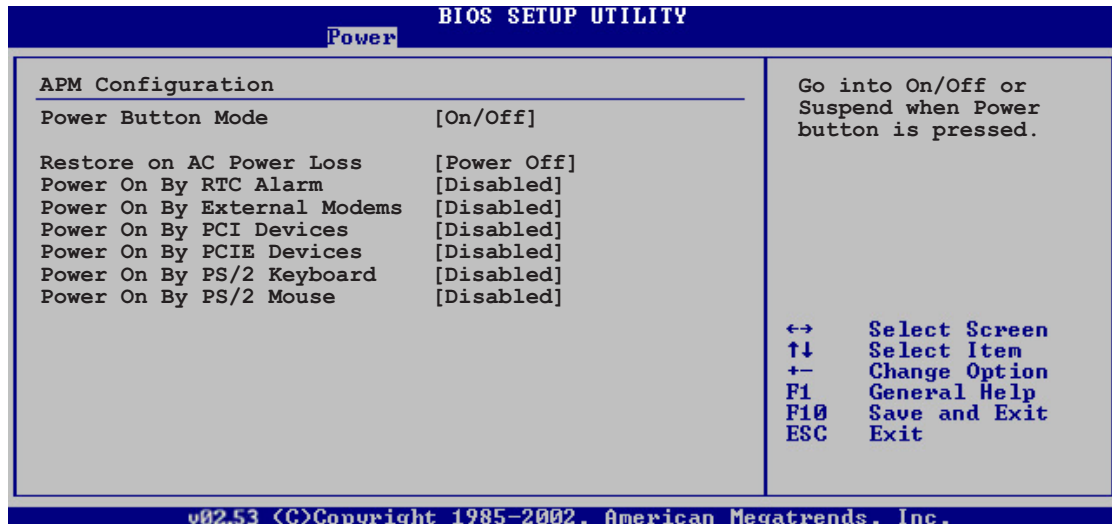

Power Button Mode [On/Off]

Allows the system to go into On/Off mode or suspend mode when the power button is pressed. Configuration options: [On/Off] [Suspend]

Restore on AC Power Loss [Power Off]

When set to Power Off, the system goes into off state after an AC power loss. When set to Power On, the system goes on after an AC power loss. When set to Last State, the system goes into either off or on state, whatever the system state was before the AC power loss. Configuration options: [Power Off] [Power On] [Last State]

Power On By RTC Alarm [Disabled]

Allows you to enable or disable RTC to generate a wake event. Configuration options: [Disabled] [Enabled]



The succeeding items appear when the **Power On By RTC Alarm** item is set to [Enabled].

RTC Alarm Date [XX]

To set the alarm date, highlight this item and press the <+> or <-> key to make the selection. Configuration options: [Everyday] [1] [2] [3]... ~ [31]

RTC Alarm Hour

To set the alarm hour, highlight this item and press the <+> or <-> key to make the selection. Configuration options: [00] [1]... ~ [23]

RTC Alarm Minute

To set the alarm minute, highlight this item and press the <+> or <-> key to make the selection. Configuration options: [00] [1]... ~ [59]

RTC Alarm Second

To set the alarm second, highlight this item and press the <+> or <-> key to make the selection. Configuration options: [00] [1]... ~ [59]

Power On By External Modems [Disabled]

Allows either settings of [Enabled] or [Disabled] for powering up the computer when the external modem receives a call while the computer is in Soft-off mode. Configuration options: [Disabled] [Enabled]



The computer cannot receive or transmit data until the computer and applications are fully running. Thus, connection cannot be made on the first try. Turning an external modem off and then back on while the computer is off causes an initialization string that turns the system power on.

Power On By PCI Devices [Disabled]

When set to [Enabled], this parameter allows you to turn on the system through a PCI LAN or modem card. This feature requires an ATX power supply that provides at least 1A on the +5VSB lead. Configuration options: [Disabled] [Enabled]

Power On By PCIE Devices [Disabled]

When set to [Enabled], this parameter allows you to turn on the system through a PCI Express device. Configuration options: [Disabled] [Enabled]

Power On By PS/2 Keyboard [Disabled]

Allows you to use specific keys on the keyboard to turn on the system. This feature requires an ATX power supply that provides at least 1A on the +5VSB lead. Configuration options: [Disabled] [Space Bar] [Ctrl-Esc] [Power Key]

Power On By PS/2 Mouse [Disabled]

When set to [Enabled], this parameter allows you to use the PS/2 mouse to turn on the system. This feature requires an ATX power supply that provides at least 1A on the +5VSB lead. Configuration options: [Disabled] [Enabled]

4.5.6 Hardware Monitor

BIOS SETUP UTILITY	
Power	
Hardware Monitor	
AI Quiet	[Disabled]
CPU Temperature	[32.5°C/90.5°F]
MB Temperature	[36.0°C/96.5°F]
Automatically optimize BIOS settings to minimize CPU FAN speed according to system loading.	
CPU Fan Speed (RPM)	[3813 RPM]
Q-Fan Control	[Disabled]
Chassis Fan1	[N/A]
Chassis Fan2	[N/A]
Chassis Q-Fan1 Control	[Disabled]
Power Fan Speed (RPM)	[N/A]
←→ Select Screen	
↑↓ Select Item	
+- Change Option	
F1 General Help	
F10 Save and Exit	
ESC Exit	
VCORE Voltage	[1.320V]
3.3V Voltage	[3.345V]
5V Voltage	[5.094V]
12V Voltage	[11.880V]

v02.53 (C)Copyright 1985-2002, American Megatrends, Inc.

AI Quiet [Disabled]

Allows you to enable or disable the AI Quiet feature, which automatically optimizes BIOS settings to minimize CPU FAN speed according to system loading. Configuration options: [Disabled] [Enabled]

CPU Temperature [xxx°C/xxx°F]

MB Temperature [xxx°C/xxx°F]

The onboard hardware monitor automatically detects and displays the motherboard and CPU temperatures. Select [Disabled] if you do not wish to display the detected temperatures.

CPU Fan Speed (RPM) [xxxxRPM] or [N/A] or [Ignored]

The onboard hardware monitor automatically detects and displays the CPU fan speed in rotations per minute (RPM). If the fan is not connected to the motherboard, the field shows N/A. Select [Ignore] from the item options to disable CPU fan speed monitoring.

Q-FAN Control [Disabled]

Allows you to enable or disable the ASUS Q-Fan feature that smartly adjusts the fan speeds for more efficient system operation. Configuration options: [Disabled] [Enabled]



The **CPU Q-Fan Mode** and **CPU Fan Profile Mode** items appear when you enable the **ASUS Q-FAN Control** feature.

CPU Q-Fan Mode [PWM]

Allows you to select the type of CPU fan cable connected to the CPU fan connector. Set to [PWM] when using a 4-pin CPU fan cable. Set to [DC] when using a 3-pin CPU fan cable. Configuration options: [PWM] [DC]



Some CPU fans with a 4-pin cable do not comply with Intel®'s PWM fan specification. When using this type of CPU fan, you can not reduce the CPU fan speed even if you set the CPU Q-Fan Mode to [PWM].

CPU Fan Profile [Optimal]

Allows you to set the appropriate CPU fan performance. When set to [Optimal], the CPU fan automatically adjusts depending on the CPU temperature. Set this item to [Silent] to minimize fan speed for quiet CPU fan operation, or [Performance] to achieve maximum CPU fan speed. Configuration options: [Optimal] [Performance Mode] [Silent]

Chassis Fan1/2 or [N/A]/[Ignored]

The onboard hardware monitor automatically detects and displays the chassis fan speed in rotations per minute (RPM). If the fan is not connected to the chassis, the specific field shows N/A. Select [Ignore] from the item options to disable chassis fan speed monitoring.

Chassis Q-Fan1 Control [Disabled]

Allows you to enable or disable the ASUS Q-Fan feature that smartly adjusts the chassis fan speeds for more efficient system operation. Configuration options: [Disabled] [Enabled]



-
- The Chassis Q-Fan function is available only on CHA_FAN1.
 - The **Chassis Fan Profile Mode** item appears when you enable the **Chassis Q-Fan Control** feature.
-

Chassis Fan Profile [Optimal]

Allows you to set the appropriate performance level of the chassis Q-Fan. Configuration options: [Optimal] [Performance Mode] [Silent Mode]

Power Fan Speed (RPM) [xxxxRPM] or [N/A]/ [Ignored]

The onboard hardware monitor automatically detects and displays the power fan speed in rotations per minute (RPM). If the fan is not connected to the power fan connector, the specific field shows N/A.

VCORE Voltage, 3.3V Voltage, 5V Voltage, 12V Voltage

The onboard hardware monitor automatically detects the voltage output through the onboard voltage regulators.

4.6 Boot menu

The Boot menu items allow you to change the system boot options. Select an item then press <Enter> to display the sub-menu.

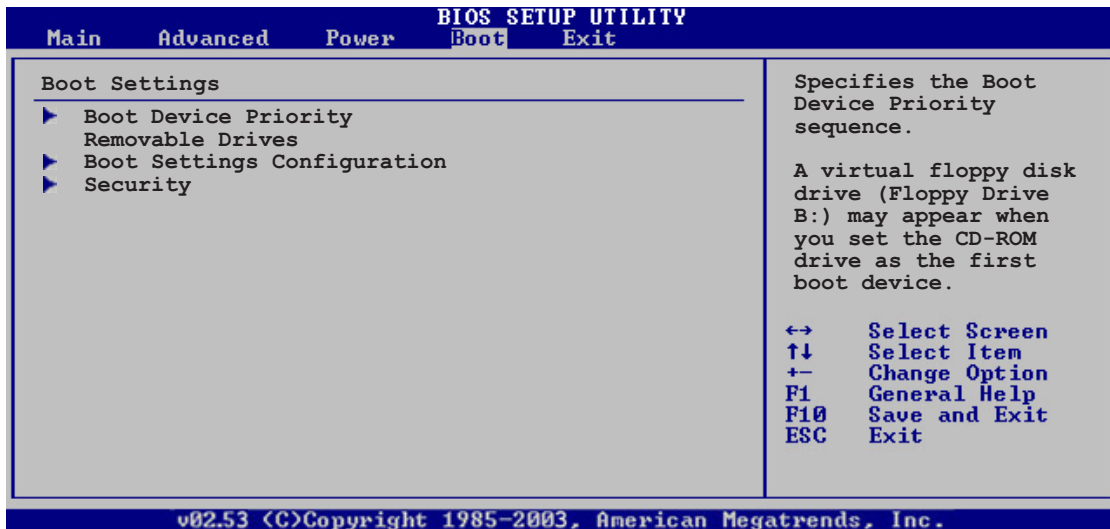

4.6.1 Boot Device Priority

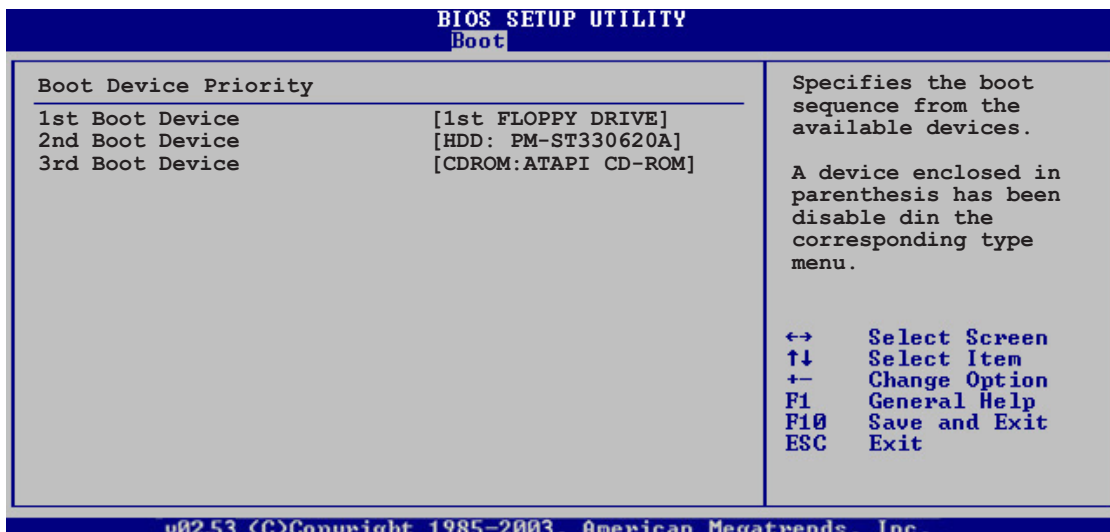

1st ~ xxth Boot Device [1st FLOPPY DRIVE]

These items specify the boot device priority sequence from the available devices. The number of device items that appears on the screen depends on the number of devices installed in the system.

Configuration options: [1st FLOPPY DRIVE] [Hard Drive] [ATAPI CD-ROM] [Disabled]

4.6.2 Removable Drives

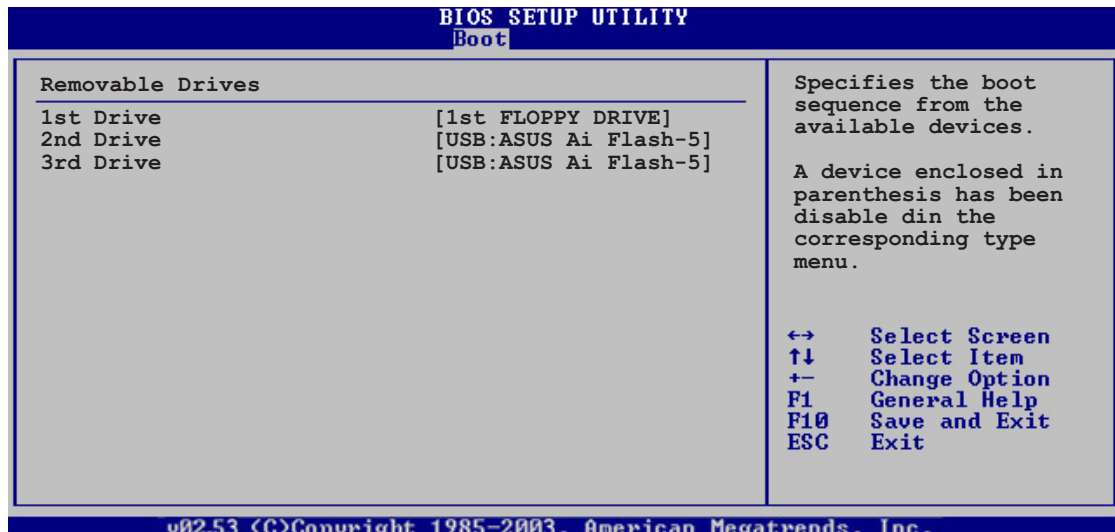

1st ~ xxth Drive [1st FLOPPY DRIVE]

These items specify the boot device priority sequence from the available devices. The number of device items that appears on the screen depends on the number of removable devices installed in the system.

Configuration options: [1st FLOPPY DRIVE] [USB:ASUS Ai Flash-5]
[Disabled]

4.6.3 Boot Settings Configuration

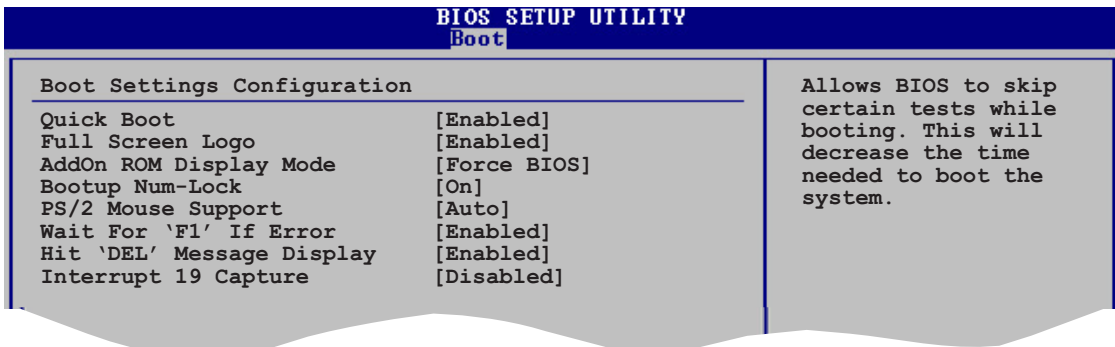

Quick Boot [Enabled]

Enabling this item allows the BIOS to skip some power on self tests (POST) while booting to decrease the time needed to boot the system. When set to [Disabled], BIOS performs all the POST items.

Configuration options: [Disabled] [Enabled]

Full Screen Logo [Enabled]

Allows you to enable or disable the full screen logo display feature.
Configuration options: [Disabled] [Enabled]



Set this item to [Enabled] to use the ASUS MyLogo2™ feature.

Add On ROM Display Mode [Force BIOS]

Sets the display mode for option ROM.
Configuration options: [Force BIOS] [Keep Current]

Bootup Num-Lock [On]

Allows you to select the power-on state for the NumLock.
Configuration options: [Off] [On]

PS/2 Mouse Support [Auto]

Allows you to enable or disable support for PS/2 mouse.
Configuration options: [Disabled] [Enabled] [Auto]

Wait for 'F1' If Error [Enabled]

When set to Enabled, the system waits for the F1 key to be pressed when error occurs. Configuration options: [Disabled] [Enabled]

Hit 'DEL' Message Display [Enabled]

When set to Enabled, the system displays the message "Press DEL to run Setup" during POST. Configuration options: [Disabled] [Enabled]

Interrupt 19 Capture [Disabled]

When set to [Enabled], this function allows the option ROMs to trap Interrupt 19. Configuration options: [Disabled] [Enabled]

4.6.4 Security

The Security menu items allow you to change the system security settings. Select an item then press <Enter> to display the configuration options.

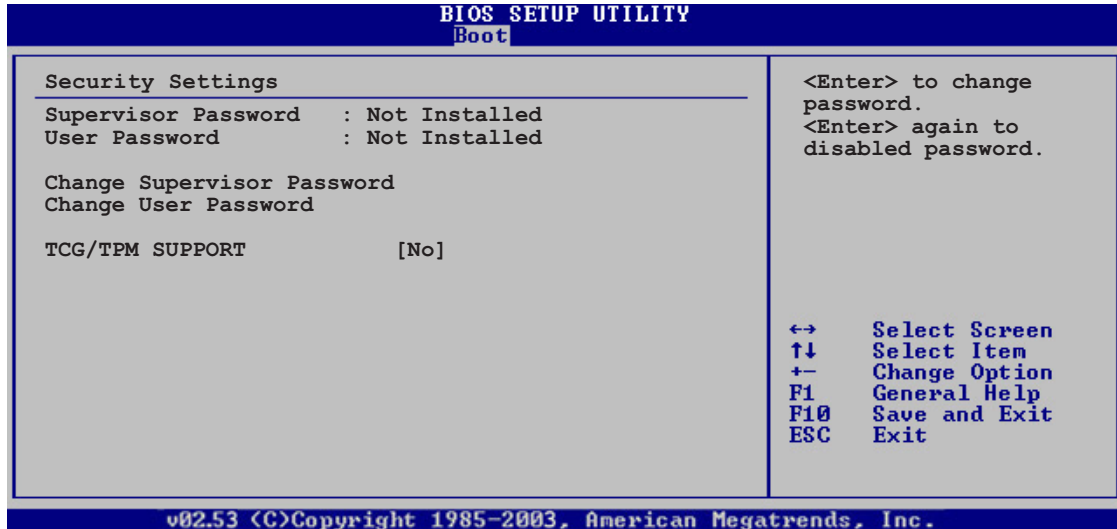

Change Supervisor Password

Select this item to set or change the supervisor password. The Supervisor Password item on top of the screen shows the default **Not Installed**. After you set a password, this item shows **Installed**.

To set a Supervisor Password:

1. Select the **Change Supervisor Password** item, then press <Enter>.
2. From the password box, type a password composed of at least six letters and/or numbers, then press <Enter>.
3. Confirm the password when prompted.

The message "Password Installed" appears after you successfully set your password.

To change the supervisor password, follow the same steps as in setting a user password.

To clear the supervisor password, select the **Change Supervisor Password** then press <Enter>. The message "Password Uninstalled" appears.



If you forget your BIOS password, you can clear it by erasing the CMOS Real Time Clock (RTC) RAM. See section "2.6 Jumpers" for information on how to erase the RTC RAM.

After you have set a supervisor password, the other items appear to allow you to change other security settings.

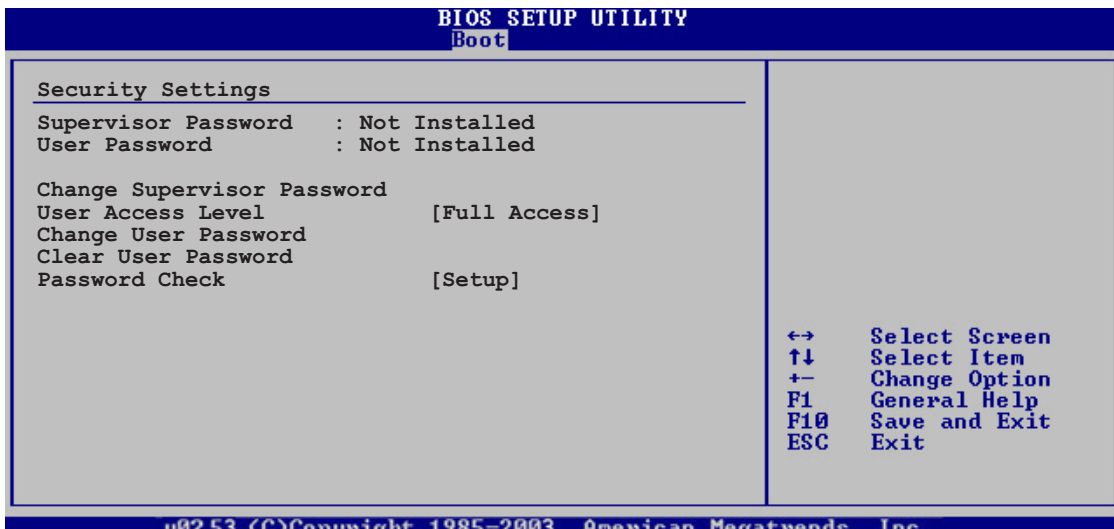

User Access Level [Full Access]

This item allows you to select the access restriction to the Setup items. Configuration options: [No Access] [View Only] [Limited] [Full Access]

No Access prevents user access to the Setup utility.

View Only allows access but does not allow change to any field.

Limited allows changes only to selected fields, such as Date and Time.

Full Access allows viewing and changing all the fields in the Setup utility.

Change User Password

Select this item to set or change the user password. The **User Password** item on top of the screen shows the default **Not Installed**. After you set a password, this item shows **Installed**.

To set a User Password:

1. Select the Change User Password item and press <Enter>.
2. On the password box that appears, type a password composed of at least six letters and/or numbers, then press <Enter>.
3. Confirm the password when prompted.

The message "Password Installed" appears after you set your password successfully.

To change the user password, follow the same steps as in setting a user password.

Clear User Password

Select this item to clear the user password.

Password Check [Setup]

When set to [Setup], BIOS checks for user password when accessing the Setup utility. When set to [Always], BIOS checks for user password both when accessing Setup and booting the system.

Configuration options: [Setup] [Always]

TCG/TPM SUPPORT [No]

Enables or disables TPM/TCG (TPM1.1/1.2) support in BIOS.

Configuration options: [Yes] [No]

4.7 Tools menu

The Tools menu items allow you to configure options for special functions. Select an item then press <Enter> to display the sub-menu.

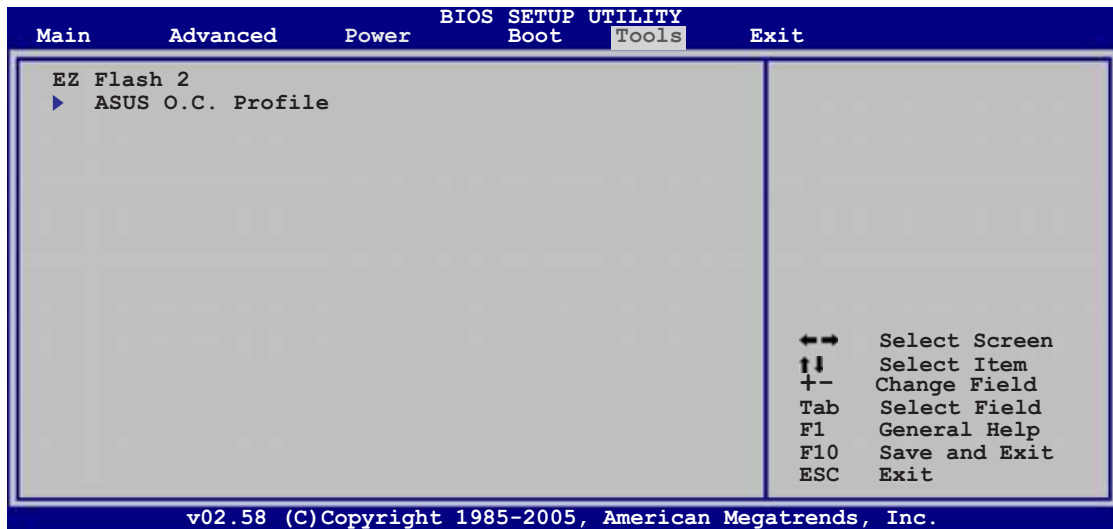

4.7.1 ASUS EZ Flash 2

Allows you to run ASUS EZ Flash 2. When you press <Enter>, a confirmation message appears. Use the left/right arrow key to select between [Yes] or [No], then press <Enter> to confirm your choice. Please see page 4-5, section 4.1.3 for details.

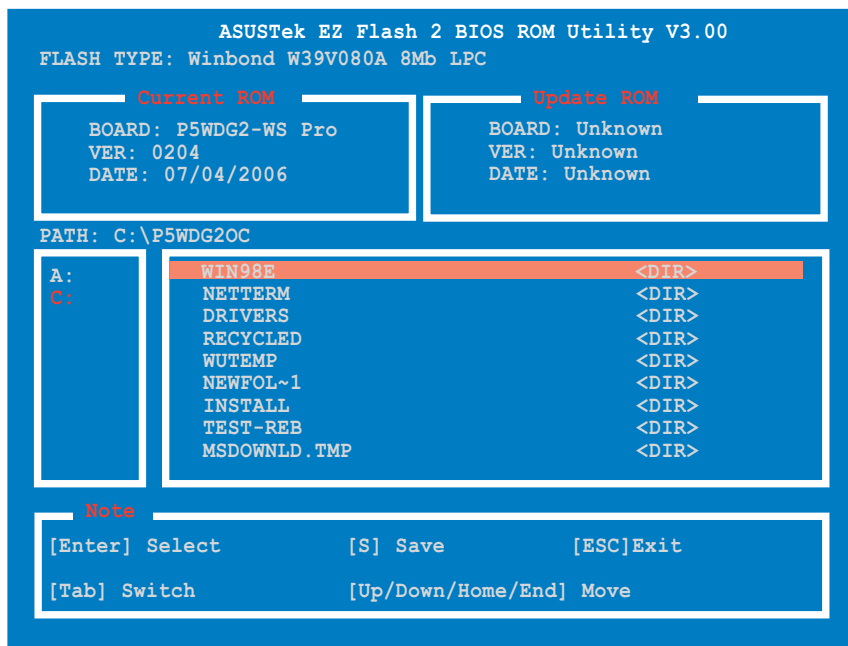

4.7.2 ASUS O.C. Profile

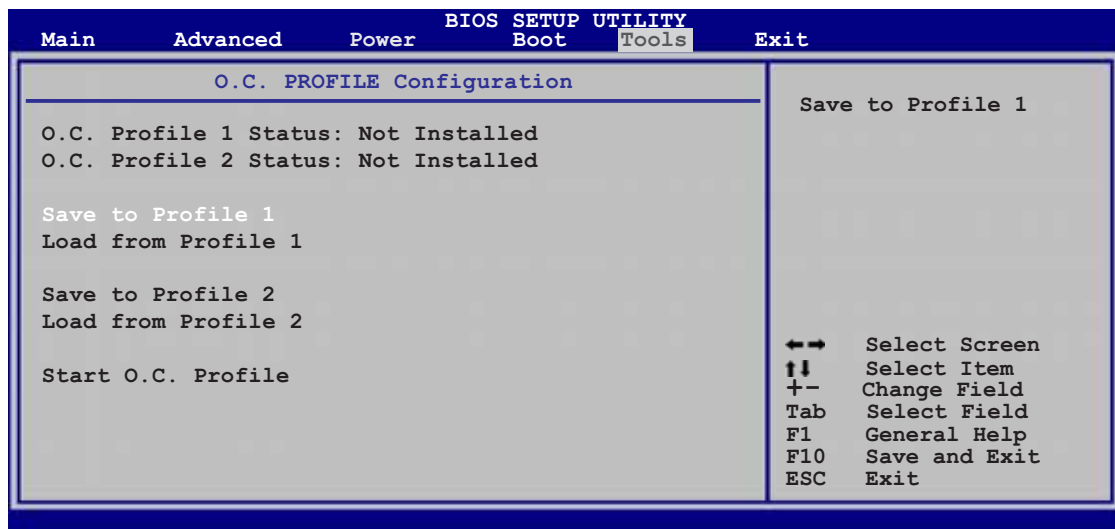

Save to Profile 1/2

Allows you to save the current BIOS file to the BIOS Flash. Press <Enter> to save the file.

Load from Profile 1/2

Allows you to load the previous BIOS settings saved in the BIOS Flash. Press <Enter> to load the file.

Start O.C. Profile

Allows you to run the utility to save and load CMOS. Press <Enter> to run the utility.

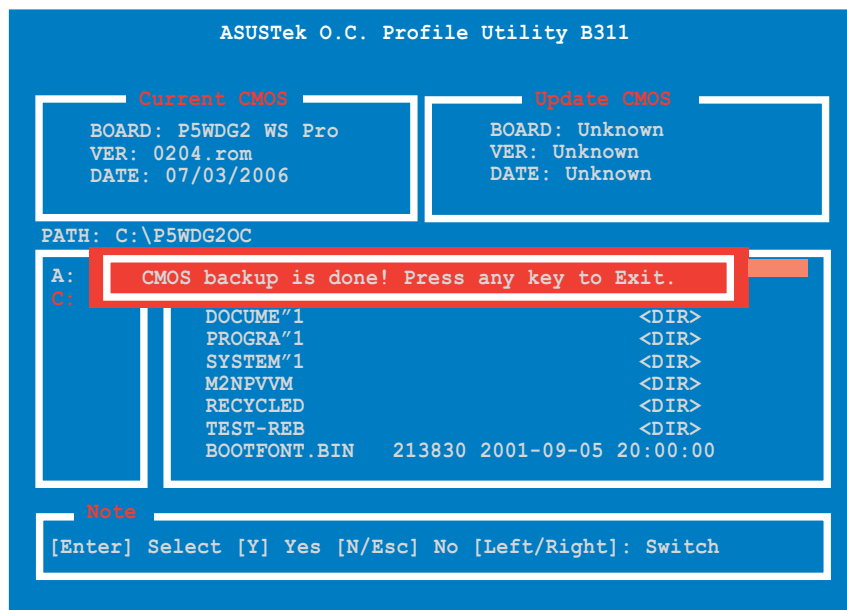



-
- This function can support devices such as USB flash disk, or floppy disk with FAT 32/16 format and single partition only.
 - Do not shutdown or reset the system while updating the BIOS to prevent system boot failure!
-

4.8 Exit menu

The Exit menu items allow you to load the optimal or failsafe default values for the BIOS items, and save or discard your changes to the BIOS items.

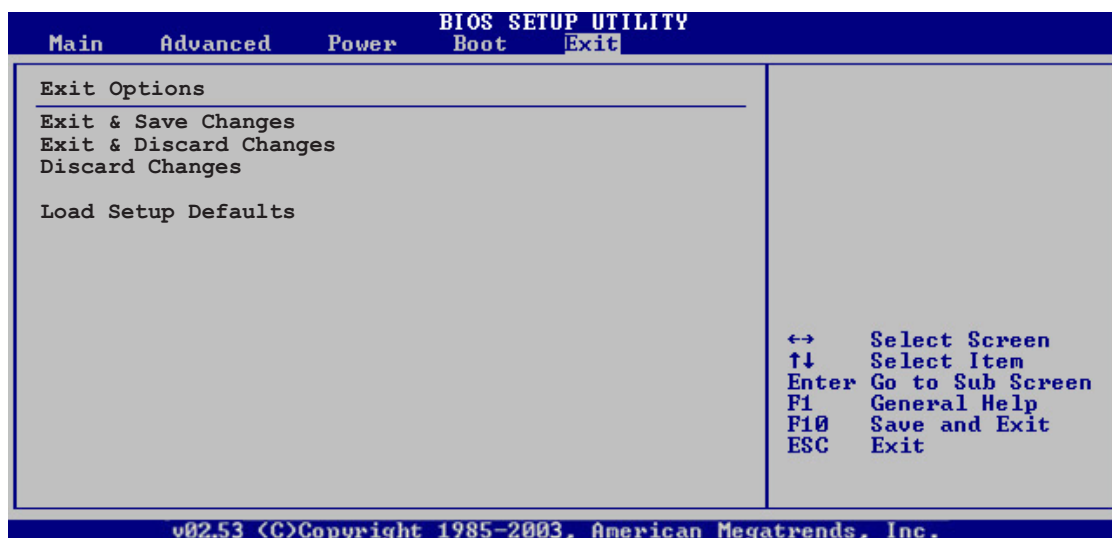

Pressing <Esc> does not immediately exit this menu. Select one of the options from this menu or <F10> from the legend bar to exit.

Exit & Save Changes

Once you are finished making your selections, choose this option from the Exit menu to ensure the values you selected are saved to the CMOS RAM. An onboard backup battery sustains the CMOS RAM so it stays on even when the computer is turned off. When you select this option, a confirmation window appears. Select **OK** to save the changes and exit.



If you attempt to exit the Setup program without saving your changes, the program prompts you with a message asking if you want to save your changes before exiting. Press <Enter> to save the changes while exiting.

Exit & Discard Changes

Select this option only if you do not want to save the changes that you made to the Setup program. If you made changes to fields other than System Date, System Time, and Password, the BIOS asks for a confirmation before exiting.

Discard Changes

Allows you to discard the selections you made and restore the previously saved values. After selecting this option, a confirmation appears. Select **Ok** to discard any changes and load the previously saved values.

Load Setup Defaults

Allows you to load the default values for each of the parameters on the Setup menus. When you select this option or if you press <F5>, a confirmation window appears. Select **Ok** to load default values. Select **Exit & Save Changes** or make other changes before saving the values to the non-volatile RAM.

This chapter describes the contents of the support CD that comes with the motherboard package.

5 Software support

5.1	Installing an operating system	5-1
5.2	Support CD information	5-1
5.3	Software information	5-11
5.4	RAID configurations	5-29
5.5	Creating a RAID driver disk	5-41

5.1 Installing an operating system

This motherboard supports Windows® 2000/2003 Server/XP operating systems (OS). Always install the latest OS version and corresponding updates to maximize the features of your hardware.



- Motherboard settings and hardware options vary. Use the setup procedures presented in this chapter for reference only. Refer to your OS documentation for detailed information.
- Make sure that you install Windows® 2000 Service Pack 4 or the Windows® XP Service Pack 1 or later versions before installing the drivers for better compatibility and system stability.

5.2 Support CD information

The support CD that came with the motherboard package contains the drivers, software applications, and utilities that you can install to avail all motherboard features.



The contents of the support CD are subject to change at any time without notice. Visit the ASUS website (www.asus.com) for updates.

5.2.1 Running the support CD

Place the support CD to the optical drive. The CD automatically displays the **Drivers** menu if Autorun is enabled in your computer.

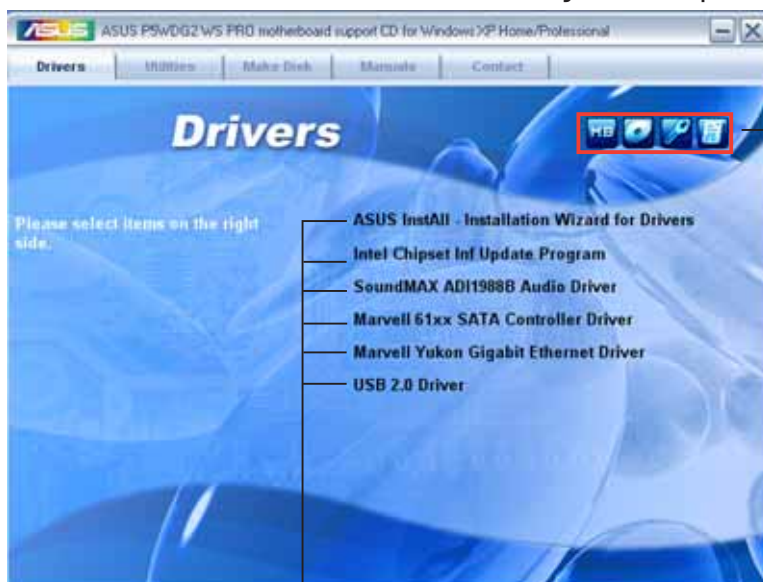

Click an icon to display support CD/motherboard information

Click an item to install



If **Autorun** is NOT enabled in your computer, browse the contents of the support CD to locate the file **ASSETUP.EXE** from the BIN folder. Double-click the **ASSETUP.EXE** to run the CD.

5.2.2 Drivers menu

The drivers menu shows the available device drivers if the system detects installed devices. Install the necessary drivers to activate the devices.



The screen display and driver options vary under different operating system versions.



ASUS InstAll - Installation Wizard for Drivers

Launches the ASUS InstAll driver installation wizard.

Intel Chipset Inf Update Program

Installs the Intel® Chipset INF Update Program. This driver enables Plug-n-Play INF support for the Intel® chipset components on the motherboard. When installed to the target system, this driver provides the method for configuring the chipset components.

You can install this utility using three different modes: interactive, silent or unattended preload. Installing the driver in interactive mode requires user input during installation. User input is not required when installing the driver in silent or unattended preload modes. Refer to the online help or readme file that came with the utility for details.

SoundMAX ADI1988B Audio Driver

Installs the SoundMAX® ADI1988B audio driver and application.

Marvell 61xx SATA controller Driver

Installs the Marvell® 61xx SATA controller driver.

Marvell Yukon Gigabit Ethernet Driver

Installs the Marvell® Yukon™ Gigabit Ethernet driver.

USB 2.0 Driver

Installs the USB 2.0 driver.

5.2.3 Utilities menu

The **Utilities** menu displays the software applications and utilities that the motherboard supports. Click on an item to install.



ASUS InstAll - Installation Wizard for Utilities

Launches the ASUS InstAll utilities installation wizard.

Marvell Yukon VCT Application

The Virtual Cable Tester (VCT) is a cable diagnostic application that analyzes and reports LAN cable faults and shorts.

ASUS AI Booster

The ASUS AI Booster application allows you to overclock the CPU speed in Windows® environment.

ASUS PC Probe II

This smart utility monitors the fan speed, CPU temperature, and system voltages, and alerts you of any detected problems. This utility helps you keep your computer in healthy operating condition.

ASUS Update

The ASUS Update utility that allows you to update the motherboard BIOS in Windows® environment. This utility requires an Internet connection either through a network or an Internet Service Provider (ISP).

ASUS AI Gear

Installs the ASUS AI Gear application.

ASUS AI Nap

Installs the ASUS AI Nap application.

ADOBE Acrobat Reader V7.0

The Adobe Acrobat® Reader V7.0 is for opening, viewing, and printing documents in Portable Document Format (PDF).

Microsoft DirectX 9.0c

The Microsoft DirectX® 9.0c is a multimedia technology that enhances computer graphics and sounds. DirectX® improves the multimedia features of your computer so you can enjoy watching TV and movies, capturing videos, or playing games in your computer.

Anti-virus Utility

The anti-virus utility scans, identifies, and removes computer viruses. View the online help for detailed information.

5.2.4 Make Disk menu

The **Make Disk** menu allows you to make RAID/Serial ATA driver disks.



Make Intel ICH7R 32/64 bit RAID Driver

Allows you to create an ICH7 RAID driver disk for a 32/64-bit system.

Marvell 6141 SATA XP/2000/2003 Driver for P5WDG2

Allows you to create a Marvell® 6141 SATA driver disk for Windows® XP/2000/2003 for P5WDG2.

Marvell 6141 SATA 64bit Driver for P5WDG2

Allows you to create a Marvell® 6141 SATA driver disk for a 64-bit system for P5WDG2.

Marvell 6145 32/64bit Driver for P5W64

Allows you to create a Marvell® 6145 SATA driver disk for a 32-/64-bit system for P5W64.

5.2.5 Manuals menu

The **Manuals** menu contains the user manuals for third party components and applications.



Most user manual files are in Portable Document Format (PDF). Install the Adobe Acrobat Reader application from the **Utilities** tab before opening a user manual file.

5.2.6 Contact information

Click the **Contact** tab to display the ASUS contact information. You can also find this information on the inside front cover of this user guide.



5.2.7 Other information

The icons on the top right corner of the screen provide additional information on the motherboard and the contents of the support CD. Click an icon to display the specified information.

Motherboard Info

Displays the general specifications of the motherboard.



Browse this CD

Displays the contents of the support CD in graphical format.

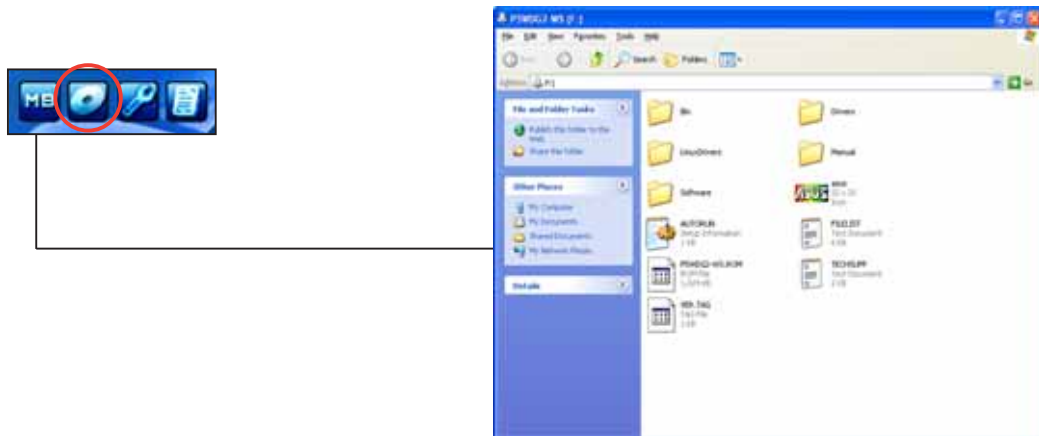

5.4 RAID configurations

The motherboard comes with the Intel® ICH7R Southbridge RAID controllers that allow you to configure Serial ATA hard disk drives as RAID sets. The motherboard supports the following RAID configurations.

RAID 0 (*Data striping*) optimizes two identical hard disk drives to read and write data in parallel, interleaved stacks. Two hard disks perform the same work as a single drive but at a sustained data transfer rate, double that of a single disk alone, thus improving data access and storage. Use of two new identical hard disk drives is required for this setup.

RAID 1 (*Data mirroring*) copies and maintains an identical image of data from one drive to a second drive. If one drive fails, the disk array management software directs all applications to the surviving drive as it contains a complete copy of the data in the other drive. This RAID configuration provides data protection and increases fault tolerance to the entire system. Use two new drives or use an existing drive and a new drive for this setup. The new drive must be of the same size or larger than the existing drive.

RAID 10 is *data striping* and *data mirroring* combined without parity (redundancy data) having to be calculated and written. With the RAID 10 configuration you get all the benefits of both RAID 0 and RAID 1 configurations. Use four new hard disk drives or use an existing drive and three new drives for this setup.

RAID 5 stripes both data and parity information across three or more hard disk drives. Among the advantages of RAID 5 configuration include better HDD performance, fault tolerance, and higher storage capacity. The RAID 5 configuration is best suited for transaction processing, relational database applications, enterprise resource planning, and other business systems. Use a minimum of three identical hard disk drives for this setup.

Intel® Matrix Storage. The Intel® Matrix Storage technology supported by the ICH7R chip allows you to create a RAID 0 and a RAID 1 set using only two identical hard disk drives. The Intel® Matrix Storage technology creates two partitions on each hard disk drive to create a virtual RAID 0 and RAID 1 sets. This technology also allows you to change the hard disk drive partition size without losing any data.



If you want to boot the system from a hard disk drive included in a created RAID set, copy first the RAID driver from the support CD to a floppy disk before you install an operating system to the selected hard disk drive. Refer to section “5.6 Creating a RAID driver disk” for details.

5.4.1 Installing Serial ATA hard disks

The motherboard supports Serial ATA hard disk drives. For optimal performance, install identical drives of the same model and capacity when creating a disk array.

To install the SATA hard disks for a RAID configuration:

1. Install the SATA hard disks into the drive bays.
2. Connect the SATA signal cables.
3. Connect a SATA power cable to the power connector on each drive.

5.4.2 Intel® RAID configurations

This motherboard supports RAID 0, RAID 1, RAID 5, RAID 10 (0+1), and Intel® Matrix Storage configurations for Serial ATA hard disks drives through the Intel® ICH7R Southbridge chip.

Setting the RAID item in BIOS

You must set the RAID item in the BIOS Setup before you can create a RAID set(s). To do this:

1. Enter the BIOS Setup during POST.
2. Go to the **Main Menu**, select **IDE Configuration**, then press <Enter>.
3. Select the item **Configure SATA As**, then press <Enter> to display the configuration options.
4. Select **RAID** from the **Configure SATA As** item options, then press <Enter>.
5. Save your changes, then exit the BIOS Setup.



Refer to the system or the motherboard user guide for details on entering and navigating through the BIOS Setup.

Intel® Matrix Storage Manager Option ROM Utility

The Intel® Matrix Storage Manager Option ROM utility allows you to create RAID 0, RAID 1, RAID 10 (RAID 0+1), and RAID 5 set(s) from Serial ATA hard disk drives that are connected to the Serial ATA connectors supported by the Southbridge.

To enter the Intel® Application Accelerator RAID Option ROM utility:

1. Install all the Serial ATA hard disk drives.
2. Turn on the system.
3. During POST, press <Ctrl+I> to display the utility main menu.

```
Intel(R) Matrix Storage Manager Option ROM v5.0.0.1032 ICH7R wRAID5
Copyright(C) 2003-05 Intel Corporation. All Rights Reserved.

-----[ MAIN MENU ]-----
1. Create RAID Volume
2. Delete RAID Volume
3. Reset Disks to Non-RAID
4. Exit

-----[ DISK/VOLUME INFORMATION ]-----

RAID Volumes:
None defined.

Physical Disks:
Port Drive Model          Serial #          Size      Type/Status(Vol ID)
0  XXXXXXXXXXXX          XXXXXXXX          XX.XXGB  Non-RAID Disk
1  XXXXXXXXXXXX          XXXXXXXX          XX.XXGB  Non-RAID Disk
2  XXXXXXXXXXXX          XXXXXXXX          XX.XXGB  Non-RAID Disk
3  XXXXXXXXXXXX          XXXXXXXX          XX.XXGB  Non-RAID Disk

[↑↓]-Select      [ESC]-Exit      [ENTER]-Select Menu
```

The navigation keys at the bottom of the screen allow you to move through the menus and select the menu options.



The RAID BIOS setup screens shown in this section are for reference only and may not exactly match the items on your screen.

Creating a RAID 0 set (striped)

To create a RAID 0 set:

1. From the utility main menu, select **1. Create RAID Volume**, then press <Enter>. This screen appears.

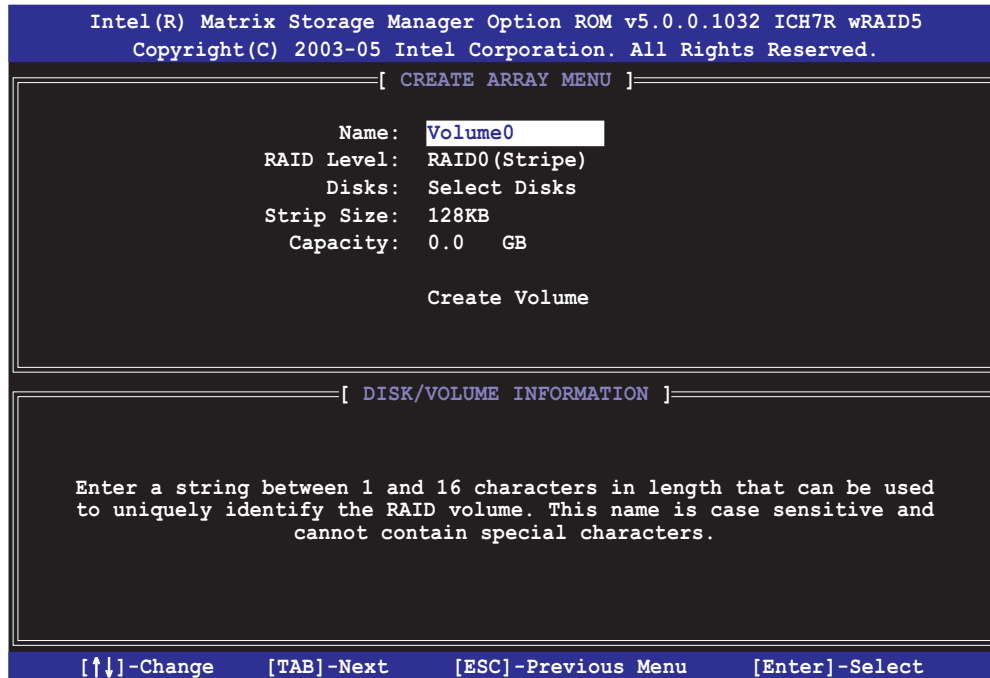

2. Enter a name for the RAID 0 set, then press <Enter>.
3. When the **RAID Level** item is highlighted, press the up/down arrow key to select **RAID 0(Stripe)**, then press <Enter>.
4. When the **Disks** item is highlighted, press <Enter> to select the hard disk drives to configure as RAID. This pop-up screen appears.

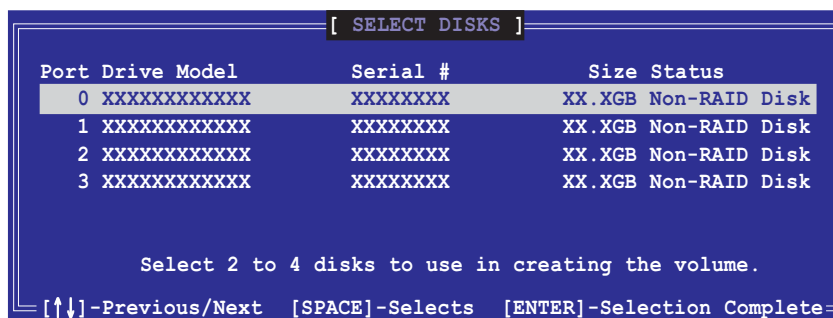

5. Use the up/down arrow key to highlight a drive, then press <Space> to select. A small triangle marks the selected drive. Press <Enter> after completing your selection.

6. Use the up/down arrow key to select the stripe size for the RAID 0 array, then press <Enter>. The available stripe size values range from 4 KB to 128 KB. The default stripe size is 128 KB.



TIP: We recommend a lower stripe size for server systems, and a higher stripe size for multimedia computer systems used mainly for audio and video editing.

7. Key in the RAID volume capacity that you want, then press <Enter>. The default value indicates the maximum allowed capacity.
8. Press <Enter> when the **Create Volume** item is highlighted. This warning message appears.

```
WARNING: ALL DATA ON SELECTED DISKS WILL BE LOST.  
Are you sure you want to create this volume? (Y/N) :
```

9. Press <Y> to create the RAID volume and return to the main menu, or <N> to go back to the Create Volume menu.

Creating a RAID 1 set (mirrored)

To create a RAID 1 set:

1. From the utility main menu, select **1. Create RAID Volume**, then press <Enter>. This screen appears.

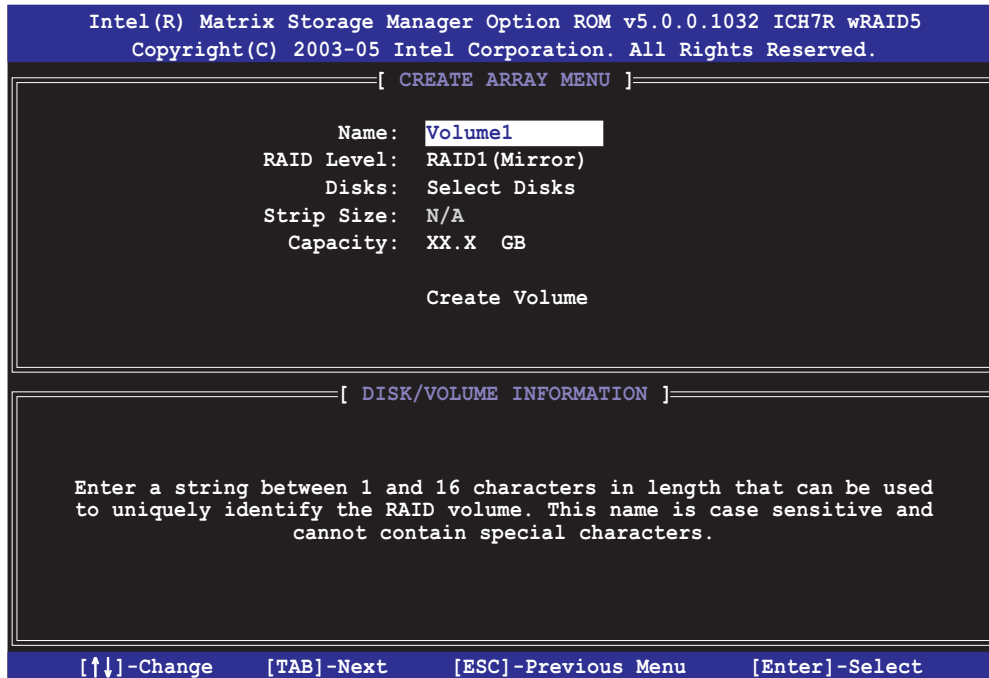

2. Enter a name for the RAID 1 set, then press <Enter>.
3. When the **RAID Level** item is highlighted, press the up/down arrow key to select **RAID 1 (Mirror)**, then press <Enter>.
4. When the **Capacity** item is highlighted, key in the RAID volume capacity that you want, then press <Enter>. The default value indicates the maximum allowed capacity.
5. Press <Enter> when the **Create Volume** item is highlighted. This warning message appears.



6. Press <Y> to create the RAID volume and return to main menu or <N> to go back to Create Volume menu.

Creating a RAID 10 set (RAID 0+1)

To create a RAID 10 set:

1. From the utility main menu, select **1. Create RAID Volume**, then press <Enter>. This screen appears.

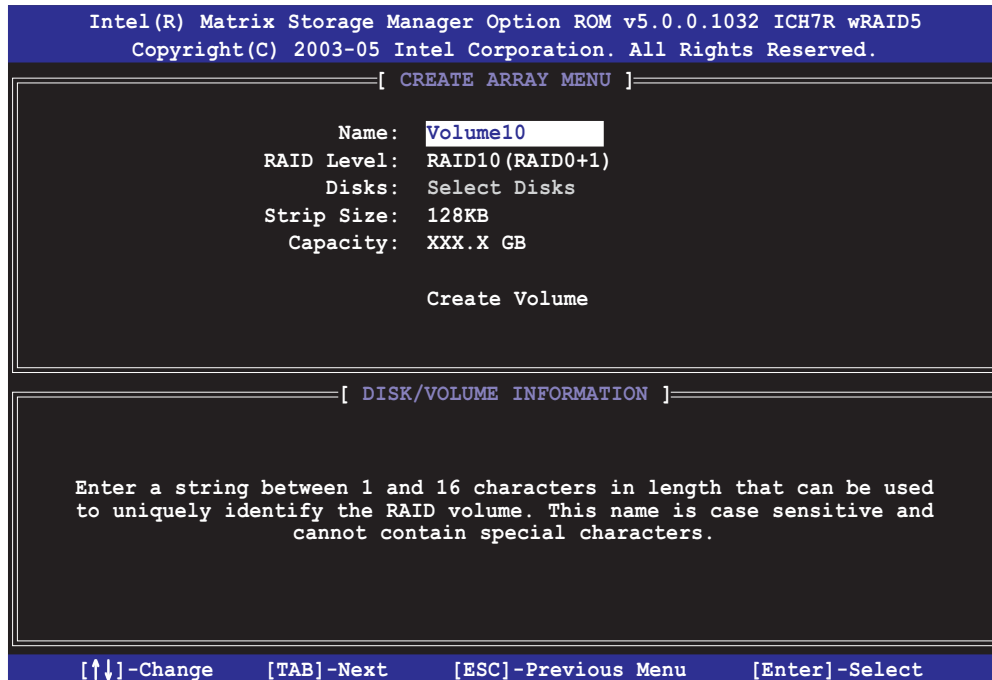

2. Enter a name for the RAID 10 set, then press <Enter>.
3. When the **RAID Level** item is highlighted, press the up/down arrow key to select **RAID 10(RAID0+1)**, then press <Enter>.
4. When the **Stripe Size** item is highlighted, press the up/down arrow key to select the stripe size for the RAID 10 array, then press <Enter>. The available stripe size values range from 4 KB to 128 KB. The default stripe size is 64 KB.



TIP: We recommend a lower stripe size for server systems, and a higher stripe size for multimedia computer systems used mainly for audio and video editing.

5. Key in the RAID volume capacity that you want then press <Enter> when the **Capacity** item is highlighted. The default value indicates the maximum allowed capacity.

6. Press <Enter> when the **Create Volume** item is highlighted. This warning message appears.

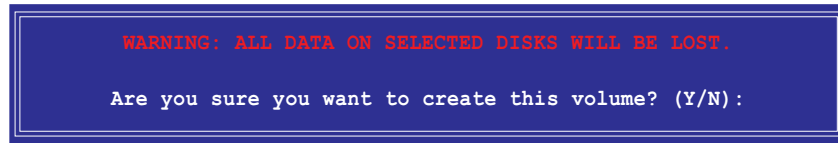

7. Press <Y> to create the RAID volume and return to the main menu or <N> to go back to the Create Volume menu.

Creating a RAID 5 set (parity)

To create a RAID 5 set:

1. From the utility main menu, select **1. Create RAID Volume**, then press <Enter>. This screen appears.

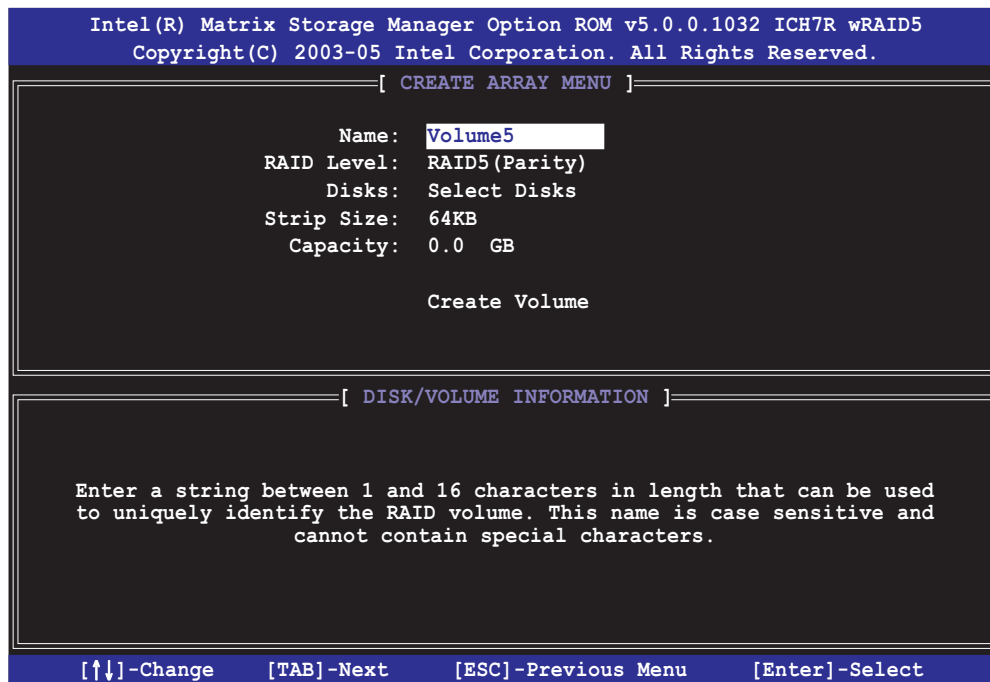

2. Enter a name for the RAID 5 set, then press <Enter>.
3. When the **RAID Level** item is highlighted, press the up/down arrow key to select **RAID 5(Parity)**, then press <Enter>.

- The Disks item is highlighted, press <Enter> to select the hard disk drives to configure as RAID. The following pop-up screen appears.

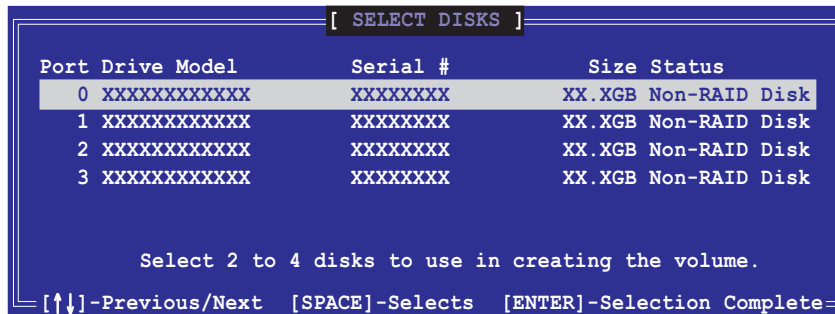

- Use the up/down arrow key to highlight the drive you want to set, then press <Space> to select. A small triangle marks the selected drive. Press <Enter> after completing your selection.
- When the **Stripe Size** item is highlighted, press the up/down arrow key to select the stripe size for the RAID 5 array, then press <Enter>. The available stripe size values range from 4 KB to 128 KB. The default stripe size is 64 KB.



TIP: We recommend a lower stripe size for server systems, and a higher stripe size for multimedia computer systems used mainly for audio and video editing.

- Key in the RAID volume capacity that you want, then press <Enter> when the **Capacity** item is highlighted. The default value indicates the maximum allowed capacity.
- Press <Enter> when the **Create Volume** item is highlighted. This warning message appears.

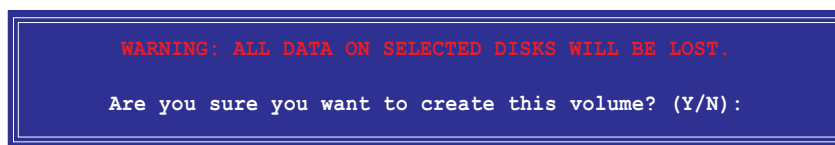

- Press <Y> to create the RAID volume and return to the main menu or <N> to go back to the Create Volume menu.

Deleting a RAID set



Take caution when deleting a RAID set. You will lose all data on the hard disk drives when you delete a RAID set.

To delete a RAID set:

1. From the utility main menu, select **2. Delete RAID Volume**, then press <Enter> to display this screen.

```
Intel(R) Matrix Storage Manager Option ROM v5.0.0.1032 ICH7R wRAID5
Copyright(C) 2003-05 Intel Corporation. All Rights Reserved.

[ DELETE VOLUME MENU ]
-----
Name           Level           Drives      Capacity  Status   Bootable
Volume0        RAIDX (xxxxx)   X           XXX.XGB   Normal   Yes
-----

[ HELP ]

Deleting a volume will destroy the volume data on the drive(s) and
cause any member disks to become available as non-RAID disks.

WARNING: EXISTING DATA WITHIN THIS VOLUME WILL BE LOST AND NON-RECOVERABLE.

[↑↓]-Select      [<ESC>]-Previous Menu    [<Del>]-Delete Volume
```

2. Use the up/down arrow key to select the RAID set you want to delete, then press . This window appears.

```
[ DELETE VOLUME VERIFICATION ]
-----
ALL DATA IN THE VOLUME WILL BE LOST!

Are you sure you want to delete volume "VolumeX"? (Y/N):
```

3. Press <Y> to delete the RAID set and return to the utility main menu; otherwise, press <N> to return to the Delete Volume menu.

Resetting Disks to Non-RAID



Take caution before you reset a RAID volume HDD to non-RAID. Resetting a RAID volume HDD deletes all internal RAID structure on the drive.

To reset a RAID set hard disk drive:

1. From the utility main menu, select **3. Reset Disks to Non-RAID**, then press <Enter> to display this screen.

```
[ RESET RAID DATA ]

Resetting RAID data will remove internal RAID structures
from the selected RAID disks. By removing these structures,
the drive will revert back to a non-RAID disk.

WARNING: Resetting a disk causes all data on the disk to be lost.

Port Drive Model          Serial #          Size Status
---  -  -  -  -  -  -  -  -  -  -  -  -  -  -  -  -  -  -  -  -  -  -  -
0  XXXXXXXXXXXX          XXXXXXXX          XX.XGB Member Disk
1  XXXXXXXXXXXX          XXXXXXXX          XX.XGB Member Disk

Select the disks that should be reset.

[↑↓]-Previous/Next [SPACE]-Selects [ENTER]-Selection Complete
```

2. Use the up/down arrow key to highlight the RAID set drive you want to reset, then press <Space> to select.
3. Press <Enter> to reset the RAID set drive. A confirmation message appears.
4. Press <Y> to reset the drive or press <N> to return to the utility main menu.

Exiting the Intel® Matrix Storage Manager utility

To exit the utility:

1. From the utility main menu, select **4. Exit**, then press <Enter>. This window appears.

```
[ CONFIRM EXIT ]

Are you sure you want to exit? (Y/N):
```

2. Press <Y> to exit or press <N> to return to the utility main menu.

Resetting a RAID set hard disks drive



Take caution before you reset a RAID volume HDD to non-RAID. Resetting a RAID volume HDD deletes all internal RAID structure on the drive.

To reset a RAID set hard disk drive:

1. From the utility main menu, select **[3. Reset Disks to Non-RAID]**, then press <Enter> to display the following screen.

```

  RESET RAID DATA

Resetting RAID data will remove the internal RAID structures
from the selected RAID disks. By removing these structures
the drive will revert back to a Non-RAID disk.

WARNING: Resetting a disk causes all data on the disk to be lost.

Port Drive Model      Serial #      Size      Status
  0 STXXXXXXXXX      XXXXXXXX    XX.0GB    Member Disk
  1 STXXXXXXXXX      XXXXXXXX    XX.0GB    Member Disk

Select the disk that should be reset

[ ↓↑ ] -Previous/Next  [ Space ] -Selects  [ Enter ] -Selection Complete
```

2. Use the up or down arrow keys to highlight the RAID set drive you want to reset, then press <Space> to select.
3. Press <Enter> to reset the RAID set drive. A confirmation window appears.
4. Press <Y> to reset the drive; otherwise, press <N> to return to the utility main menu.
5. Follow steps 2 to 4 to select and reset other RAID set drives.

5.5 Creating a RAID driver disk

A floppy disk with the RAID driver is required when installing Windows® 2000/XP operating system on a hard disk drive that is included in a RAID set. You can create a RAID driver disk in DOS (using the Makedisk application in the support CD) or in Windows® environment.

To create a RAID driver disk in DOS environment:

1. Place the motherboard support CD in the optical drive.
2. Restart the computer, then enter the BIOS Setup.
3. Select the optical drive as the first boot priority to boot from the support CD. Save your changes, then exit the BIOS Setup.
4. Restart the computer.
5. Press any key when prompted to boot from CD.

```
Loading FreeDOS FAT KERNEL GO!  
Press any key to boot from CDROM...
```

The Makedisk menu appears.

```
1) Make ICH7R 32-bit RAID driver disk  
2) Make ICH7R 64-bit RAID driver disk  
3) Make Marvell 88SE6140 SATA2 RAID driver disk  
4) Format floppy disk  
5) FreeDOS command prompt  
Please choose 1 ~ 6
```

6. Place a blank, high-density floppy disk to the floppy disk drive, then press the corresponding number to format the floppy disk. The following message displays on screen.

```
Insert new diskette for drive B:\  
and press ENTER when ready...
```

7. Press <Enter> to format the floppy disk.
8. When finished, select the type of RAID driver disk you want to create by typing the number preceding the option, then press <Enter>. The following message appears on screen.

```
Please insert your formatted floppy to drive B:\  
Press a key to continue.
```



The screens shown in this section are for reference only, and may not exactly match the items on your screen.

9. The RAID drivers are copied to the floppy disk. After creating a RAID driver disk, eject the floppy disk, then write-protect it to prevent computer virus infection.
10. Press any key to return to the Makedisk menu.

To create a RAID driver disk in Windows® environment:

1. Place the motherboard support CD in the optical drive.
2. Click the **Make Disk** menu tab, then select the RAID driver disk you wish to create:
 - Click **Make ICH7R 32 bit RAID Driver Disk** to create an Intel® ICH7R RAID driver disk for a 32-bit system.
 - Click **Make ICH7R 64 bit RAID Driver Disk** to create an Intel® ICH7R RAID driver disk for a 64-bit system.
 - Click **Make Marvell 88SE6141 SATA2 RAID Driver Disk** to create a Marvell® 88SE6141 SATA2 RAID driver disk for a 32-bit system.

Or

Browse the contents of the support CD to locate the driver disk utility.



Refer to section “5.2.4 Make Disk menu” for details.

3. Insert a formatted high-density floppy disk to the floppy disk drive.
4. Follow screen instructions to complete the process.
5. After creating a RAID driver disk, eject the floppy disk, then write-protect it to prevent computer virus infection.

To install the RAID driver:

1. Install an operating system to the selected hard disk drive. During installation, the computer prompts you to press the **F 6** key if you are installing a third-party SCSI or RAID driver.
2. Press <F6>, then insert the RAID driver disk to the floppy disk drive.
3. Follow screen instructions to install the RAID drivers.

5.3 Software information

Most of the applications in the support CD have wizards that will conveniently guide you through the installation. View the online help or readme file that came with the software application for more information.

5.3.1 ASUS MyLogo2™

The ASUS MyLogo2™ utility lets you customize the boot logo. The boot logo is the image that appears on screen during the Power-On-Self-Tests (POST). The ASUS MyLogo2™ is automatically installed when you install the **ASUS Update** utility from the support CD. See section “5.2.3 Utilities menu” for details.



- Before using the ASUS MyLogo2™, use the AFUDOS utility to make a copy of your original BIOS file, or obtain the latest BIOS version from the ASUS website. See section “4.1.4 AFUDOS utility.”
- Make sure that the BIOS item **Full Screen Logo** is set to [Enabled] if you wish to use ASUS MyLogo3. See section “4.6.2 Boot Settings Configuration.”
- You can create your own boot logo image in GIF, JPG, or BMP file formats.

To launch the ASUS MyLogo2™:

1. Launch the ASUS Update utility. Refer to section “4.1.1 ASUS Update utility” for details.
2. Select **Options** from the drop down menu, then click **Next**.
3. Check the option **Launch MyLogo to replace system boot logo before flashing BIOS**, then click **Next**.
4. Select **Update BIOS from a file** from the drop down menu, then click **Next**.
5. When prompted, locate the new BIOS file, then click **Next**. The ASUS MyLogo2 window appears.
6. From the left window pane, select the folder that contains the image you intend to use as your boot logo.



7. When the logo images appear on the right window pane, select an image to enlarge by clicking on it.



8. Adjust the boot image to your desired size by selecting a value on the **Ratio** box.



9. When the screen returns to the ASUS Update utility, flash the original BIOS to load the new boot logo.
10. After flashing the BIOS, restart the computer to display the new boot logo during POST.

5.3.2 AI NET2

The AI NET2 features the Marvell® Virtual Cable Tester™ (VCT). VCT is a cable diagnostic utility that reports LAN cable faults and shorts using the Time Domain Reflectometry (TDR) technology. The VCT detects and reports open and shorted cables, impedance mismatches, pair swaps, pair polarity problems, and pair skew problems of up to 64 ns at one meter accuracy.

The VCT feature reduces networking and support costs through a highly manageable and controlled network system. This utility can be incorporated in the network systems software for ideal field support as well as development diagnostics.

Using the Virtual Cable Tester™

To use the the Marvell® Virtual Cable Tester™ utility:

1. Launch the VCT utility from the Windows® desktop by clicking **Start > All Programs > Marvell > Virtual Cable Tester**.
2. Click **Virtual Cable Tester** from the menu to display the screen below.

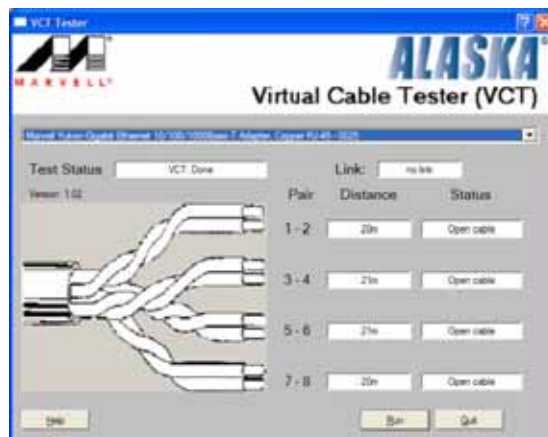

3. Click the **Run** button to perform a cable test.



- The VCT only runs on systems with Windows® XP or Windows® 2000 operating systems.
- The VCT utility only tests Ethernet cables connected to Gigabit LAN port(s).
- The **Run** button on the Virtual Cable Tester™ main window is disabled if no problem is detected on the LAN cable(s) connected to the LAN port(s).
- If you want the system to check the status of the LAN cable before entering the OS, enable the item **Post Check LAN Cable** in the BIOS Setup.
- AI NET2 is available only on LAN2.

5.3.3 AI Gear

ASUS AI Gear provides four system performance options that allows you to select the best performance setting for your computing needs. This easy-to-use utility adjusts the processor frequency and VCore voltage to minimize system noise and power consumption.

After installing AI Gear from the bundled support CD, you can launch AI Gear by double-clicking the AI Gear icon on your Windows OS taskbar.

Shift the gear to the performance setting that you like.

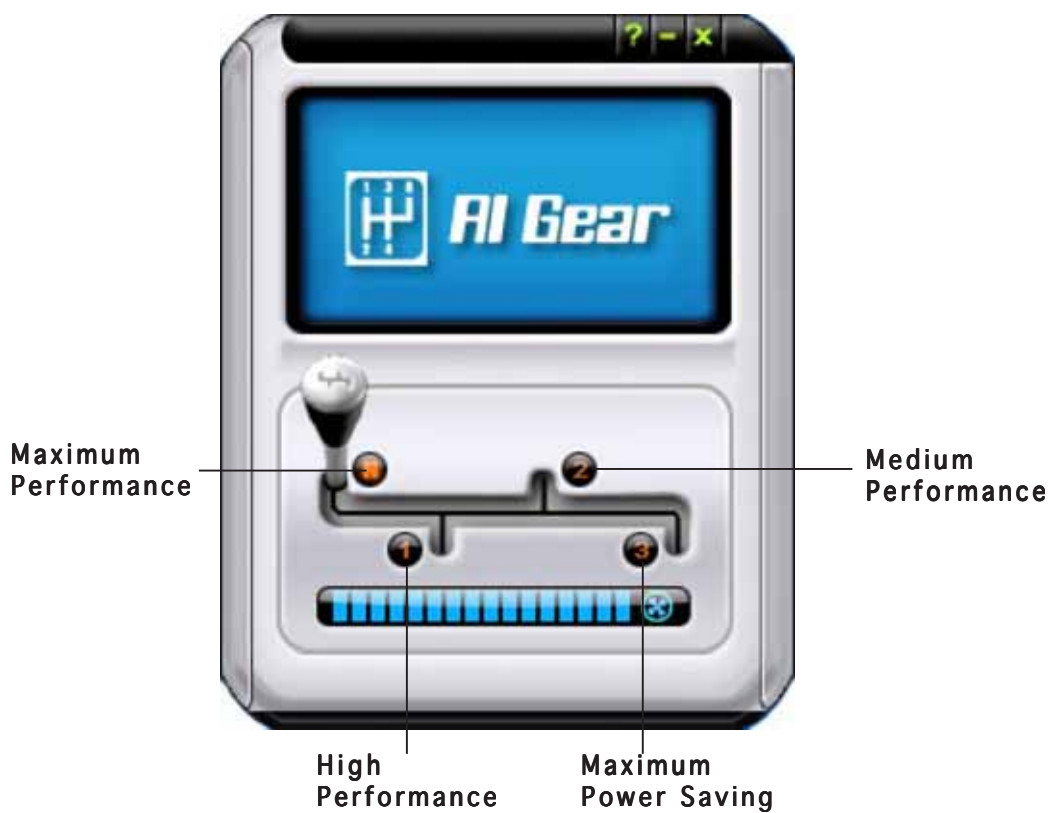

You can also set the AI Gear modes by clicking the AI Gear icon on the Windows taskbar.



-
- When AI Gear is enabled, the system will automatically optimize the CPU and chassis fan speed according to the system loading.
 - The AI Booster (AI NOS) and AI Gear functions cannot be enabled simultaneously.
-

5.3.4 AI Nap

This feature allows you to minimize the power consumption of your computer whenever you are away. Enable this feature for minimum power consumption and a more quiet system operation.

After installing AI Nap from the bundled support CD, you can launch the utility by double-clicking the AI Nap icon on the Windows OS taskbar. Click **Yes** on the confirmation screen.



To exit AI Nap mode, press the system power or mouse button then click **Yes** on the confirmation screen.

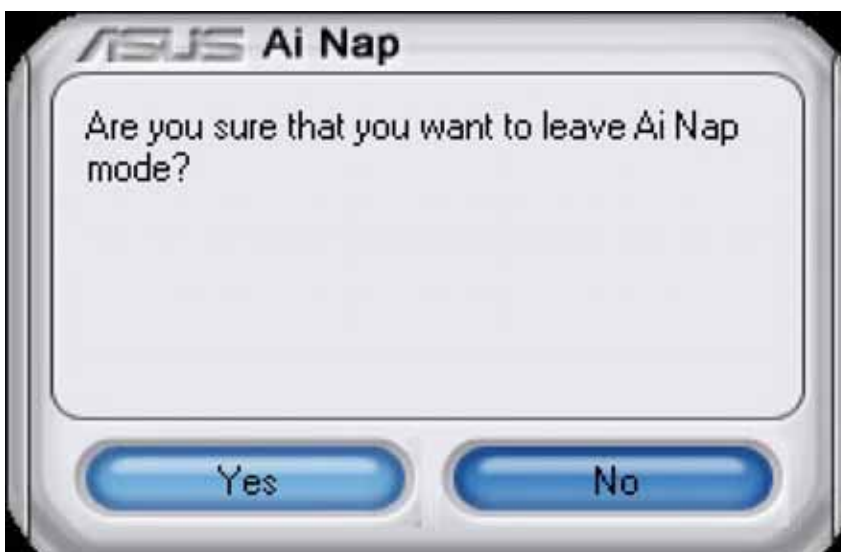

5.3.5 AI Booster

The ASUS Ai Booster application allows you to overclock the CPU speed in Windows® environment without the hassle of booting the BIOS.

After installing AI Booster from the bundled support CD, you can launch the utility by double-clicking the AI Booster icon on the Windows® OS taskbar.



The options on the task bar allow you to use the default settings, adjust CPU/Memory/PCI-E frequency manually, or create and apply your personal overclocking configurations.

5.3.6 ASUS PC Probe II

PC Probe II is a utility that monitors the computer's vital components, and detects and alerts you of any problem with these components. PC Probe II senses fan rotations, CPU temperature, and system voltages, among others. Because PC Probe II is software-based, you can start monitoring your computer the moment you turn it on. With this utility, you are assured that your computer is always at a healthy operating condition.

Installing PC Probe II

To install PC Probe II on your computer:

1. Place the support CD to the optical drive. The **Drivers** installation tab appears if your computer has an enabled Autorun feature.



If Autorun is not enabled in your computer, browse the contents of the support CD to locate the setup.exe file from the ASUS PC Probe II folder. Double-click the setup.exe file to start installation.

2. Click the **Utilities** tab, then click **ASUS PC Probe II**.
3. Follow the screen instructions to complete installation.

Launching PC Probe II

You can launch the PC Probe II right after installation or anytime from the Windows® desktop.

To launch the PC Probe II from the Windows® desktop, click **Start > All Programs > ASUS > PC Probe II > PC Probe II v1.00.43**. The PC Probe II main window appears.

After launching the application, the PC Probe II icon appears in the Windows® taskbar. Click this icon to close or restore the application.









Using PC Probe II

Main window

The PC Probe II main window allows you to view the current status of your system and change the utility configuration. By default, the main window displays the **Preference** section. You can close or restore the **Preference** section by clicking on the triangle on the main window right handle.



Click to close the Preference panel

Button	Function
	Opens the Configuration window
	Opens the Report window
	Opens the Desktop Management Interface window
	Opens the Peripheral Component Interconnect window
	Opens the Windows Management Instrumentation window
	Opens the hard disk drive, memory, CPU usage window
	Shows/Hides the Preference section
	Minimizes the application
	Closes the application

Sensor alert

When a system sensor detects a problem, the main window right handle turns red, as the illustrations below show.

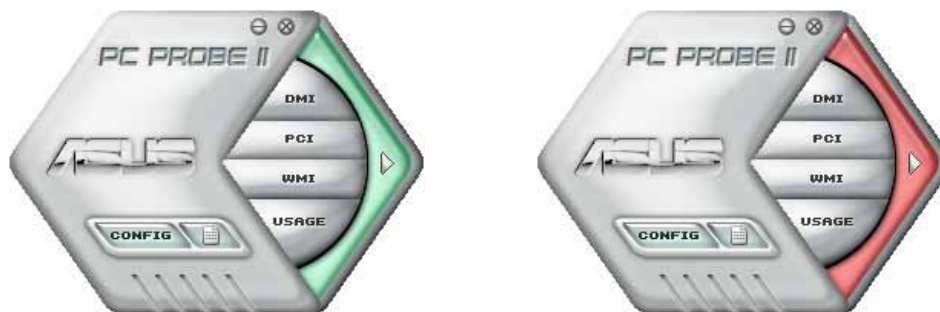

When displayed, the monitor panel for that sensor also turns red. Refer to the **Monitor panels** section for details.

Preferences

You can customize the application using the Preference section in the main window. Click the box before each preference to activate or deactivate.

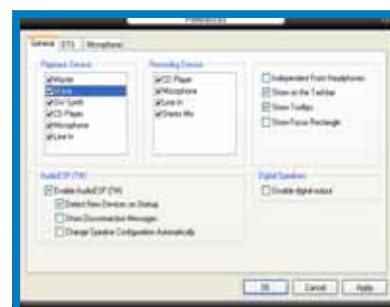

Hardware monitor panels

The hardware monitor panels display the current value of a system sensor such as fan rotation, CPU temperature, and voltages.

The hardware monitor panels come in two display modes: hexagonal (large) and rectangular (small). When you check the **Enable Monitoring Panel** option from the **Preference** section, the monitor panels appear on your computer's desktop.



Large display



Small display

Changing the monitor panels position

To change the position of the monitor panels in the desktop, click the arrow down button of the **Scheme** options, then select another position from the list box. Click **OK** when finished.

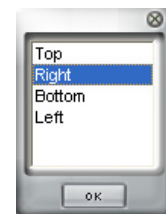

Moving the monitor panels

All monitor panels move together using a magnetic effect. If you want to detach a monitor panel from the group, click the horseshoe magnet icon. You can now move or reposition the panel independently.

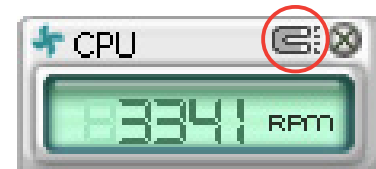

Adjusting the sensor threshold value

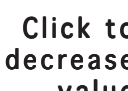
You can adjust the sensor threshold value in the monitor panel by clicking the  or  buttons. You can also adjust the threshold values using the **Config** window.

You cannot adjust the sensor threshold values in a small monitoring panel.

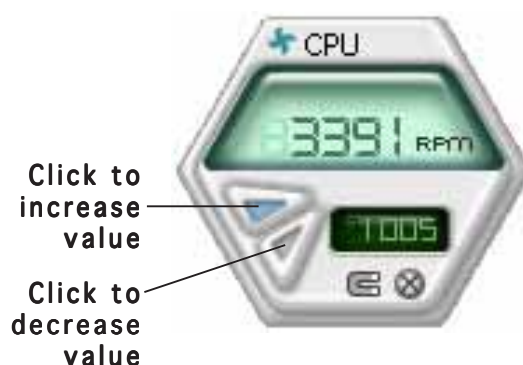

Monitoring sensor alert

The monitor panel turns red when a component value exceeds or is lower than the threshold value. Refer to the illustrations below.



Large display



Small display

WMI browser

Click **WMI** to display the WMI (Windows Management Instrumentation) browser. This browser displays various Windows® management information. Click an item from the left panel to display on the right panel. Click the plus sign (+) before **WMI Information** to display the available information.



You can enlarge or reduce the browser size by dragging the bottom right corner of the browser.

DMI browser

Click **DMI** to display the DMI (Desktop Management Interface) browser. This browser displays various desktop and system information. Click the plus sign (+) before **DMI Information** to display the available information.



PCI browser

Click **PCI** to display the PCI (Peripheral Component Interconnect) browser. This browser provides information on the PCI devices installed on your system. Click the plus sign (+) before the **PCI Information** item to display available information.



Usage

The **Usage** browser displays real-time information on the CPU, hard disk drive space, and memory usage. Click **USAGE** to display the Usage browser.

CPU usage

The **CPU** tab displays real-time CPU usage in line graph representation. If the CPU has an enabled Hyper-Threading, two separate line graphs display the operation of the two logical processors.

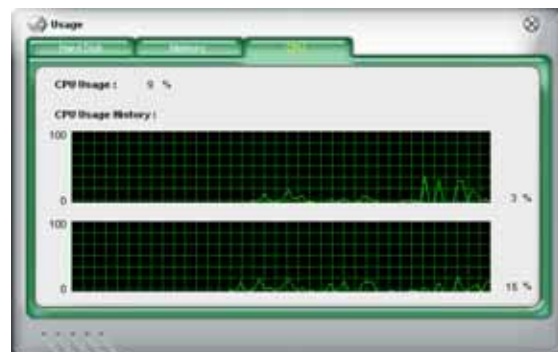

Hard disk drive space usage

The **Hard Disk** tab displays the used and available hard disk drive space. The left panel of the tab lists all logical drives. Click a hard disk drive to display the information on the right panel. The pie chart at the bottom of the window represents the used (blue) and the available HDD space.



Memory usage

The Memory tab shows both used and available physical memory. The pie chart at the bottom of the window represents the used (blue) and the available physical memory.



Configuring PC Probe II

Click **CONFIG** to view and adjust the sensor threshold values.

The **Config** window has two tabs: **Sensor/Threshold** and **Preference**. The **Sensor/Threshold** tab enables you to activate the sensors or to adjust the sensor threshold values. The **Preference** tab allows you to customize sensor alerts, or change the temperature scale.

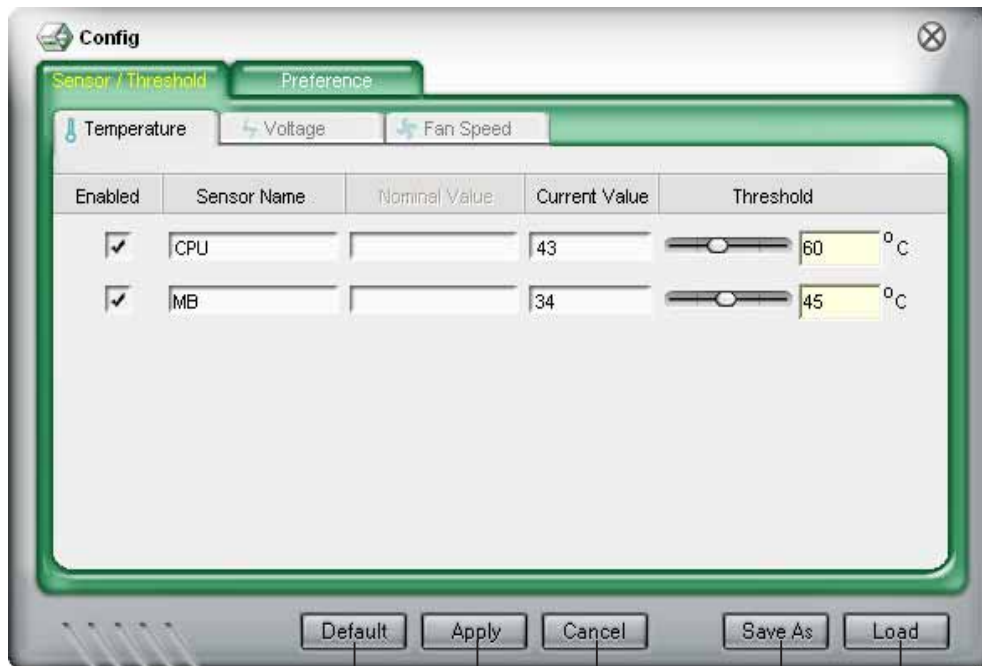

Loads the default threshold values for each sensor

Applies your changes

Cancels or ignores your changes

Loads your saved configuration

Saves your configuration

5.3.7 SoundMAX® High Definition Audio utility

The ADI AD1988B High Definition Audio CODEC provides 8-channel audio capability through the SoundMAX® audio utility with AudioESP™ software to deliver the ultimate audio experience on your PC. The software implements high quality audio synthesis/rendering, 3D sound positioning, and advanced voice-input technologies.

Follow the installation wizard to install the ADI AD1988B Audio Driver from the support CD that came with the motherboard package to activate the SoundMAX® audio utility.



-
- You must use 4-channel, 6-channel or 8-channel speakers for this setup.
 - SoundMAX® requires Microsoft® Windows® 2000/XP or later version. Make sure that one of these operating systems is installed before installing SoundMAX®.
 - Jack Retasking function works on High Definition front panel audio ports only.
-

If the SoundMAX® audio utility is correctly installed, you will find the SoundMAX® icon on the taskbar.



From the taskbar, double-click on the SoundMAX® icon to display the SoundMAX® Control Panel.



Audio Setup Wizard

By clicking the  icon from the SoundMAX® control panel, you can easily configure your audio settings. Simply follow succeeding screen instructions and begin enjoying High Definition Audio.



Jack configuration

This screen helps you configure your computer's audio ports, depending on the audio devices you have installed.



Adjust speaker volume

This screen helps you adjust speaker volume. Click the **Test** button to hear the changes you have made.



Adjust microphone volume

This screen helps you adjust microphone volume. You will be asked to read pre-written text to allow the AudioWizard to adjust the volume as you speak.



Audio preferences

Click the  icon to go to the Preferences page. This page allows you to change various audio settings.

General options

Click the General tab to choose your playback and recording devices, enable/disable the AudioESP™ feature, and enable/disable digital output.

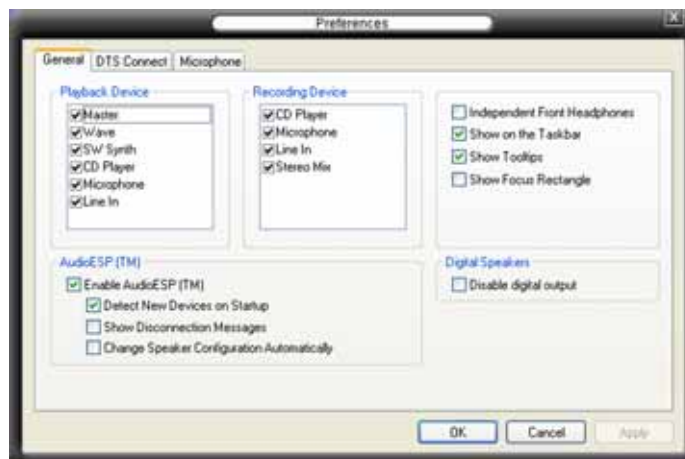

DTS.

This feature consists of two elements: DTS interactive and DTS NEO:PC. DTS interactive re-encodes your stereo or multi-channel sound into a DTS audio signal and send it out from your PC to any DTS enabled system.

While DTS NEO:PC turns your stereo audio such as MP3, WMA, CD, and other sound format into a convincing multi-channel audio experience.

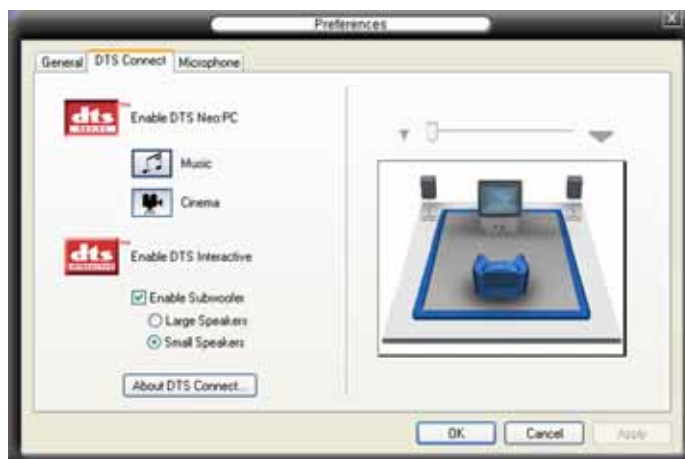

Microphone options

Click the Listening Environment tab allows you to optimize your microphone input settings.



Enhanced Microphone Features

No Filtering

Enables Noise Filter function. Detects repetitive and stationary noises like computer fans, air conditioners, and other background noises then eliminates it in the incoming studio stream while recording. You can enable it for a better recording quality.

Voice Recording

Receives only the sound coming from the reception cone and eliminates interferences including neighboring speakers and reverberations. You can enable it to transit clearer sound during on-line games, MSN, or Skype.

The Appendix describes the CPU features and technologies that the motherboard supports.

Appendix A CPU features

Chapter summary



A.1	Intel® EM64T	A-1
A.2	Enhanced Intel SpeedStep® Technology (EIST)	A-1
A.3	Intel® Hyper-Threading Technology	A-3

A.1 Intel® EM64T

The motherboard supports Intel® Pentium® 4 CPUs with the Intel® EM64T (Extended Memory 64 Technology). The Intel® EM64T feature allows your computer to run on 64-bit operating systems and access larger amounts of system memory for faster and more efficient computing.



The motherboard is fully compatible with Intel® LGA 775 processors running on 32-bit operating systems.

Using the Intel® EM64T feature

To use the Intel® EM64T feature:

1. Install an Intel® Pentium® 4 CPU that supports the Intel® EM64T.
2. Install a 64-bit operating system (Windows® XP Professional x64 Edition or Windows® Server 2003 x64 Edition).
3. Install the 64-bit drivers for the motherboard components and devices from the support CD.
4. Install the 64-bit drivers for expansion cards or add-on devices, if any.



Refer to the expansion card or add-on device(s) documentation, or visit the related website, to verify if the card/device supports a 64-bit system.

A.2 Enhanced Intel SpeedStep® Technology (EIST)

The Enhanced Intel SpeedStep® Technology (EIST) intelligently manages the CPU resources by automatically adjusting the CPU voltage and core frequency depending on the CPU loading and system speed/power requirement.

System requirements

- Intel® Pentium® 4 processor with EIST support
- BIOS file with EIST support
- Operating system with EIST support (Windows® XP SP2/Windows® Server 2003 SP1/Linux 2.6 kernel or later versions)

Using the EIST

To use the EIST feature:

1. Turn on the computer, then enter the BIOS Setup.
2. Go to the **Advanced Menu**, highlight **CPU Configuration**, then press <Enter>.
3. Scroll down the options, select the **Intel(R) SpeedStep Technology** item, then press <Enter>. Refer to the BIOS screen on the next page.

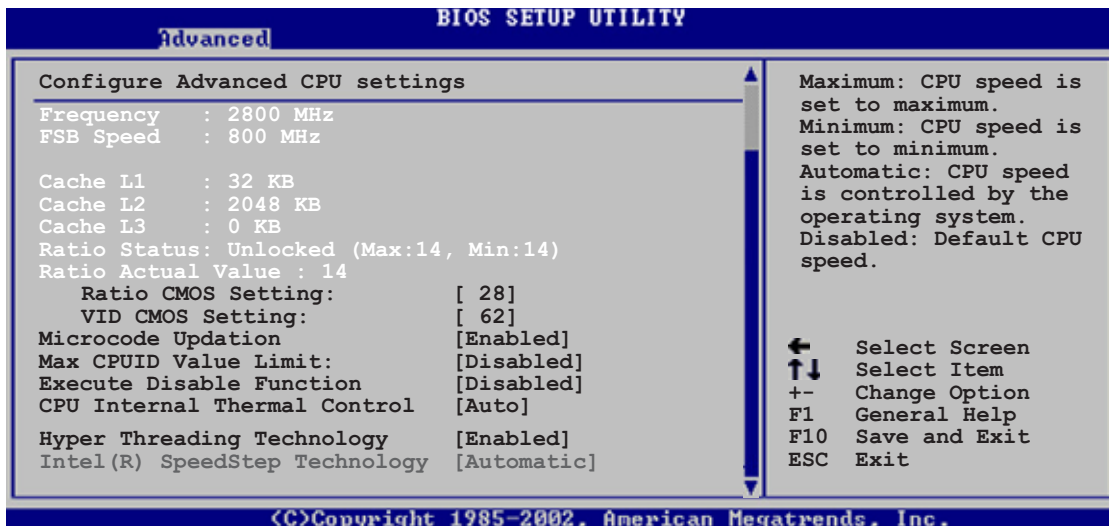

4. Select **Automatic** (default) from the options, then press <Enter>.



Set this item to [Maximum] or [Disabled] if you do not want to use the EIST feature. The CPU constantly operates at a lower internal frequency if you set this item to [Minimum].

5. Press <F10> to save your changes and exit the BIOS setup.
6. After the computer restarts, right click on a blank space on the desktop, then select **Properties** from the pop-up menu.
7. When the **Display Properties** window appears, click the **Screen Saver** tab.
8. Click the **Power** button on the Monitor power section to open the **Power Options Properties** window.
9. On the **Power schemes** section, click , then select any option except **Home/Office Desktop** or **Always On**.
10. Click **Apply**, then click **OK**.
11. Close the **Display Properties** window.
After you adjust the power scheme, the CPU internal frequency slightly decreases when the CPU loading is low.

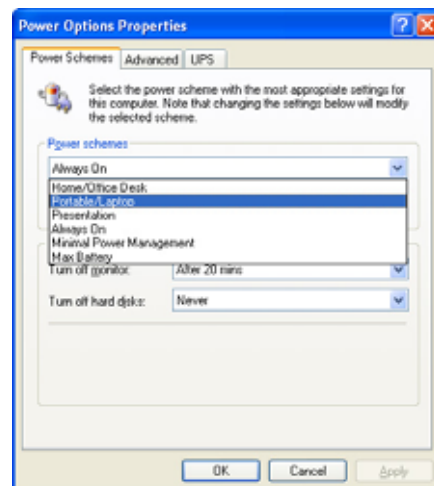

- The motherboard comes with a BIOS file that supports EM64T and EIST. You can download the latest BIOS file from the ASUS website (www.asus.com/support/download/) if you need to update the BIOS file.
- The screen displays and procedures may vary depending on the operating system.
- Visit www.intel.com for more information on the EM64T and EIST features.
- Visit www.microsoft.com for more information on Windows® 64-bit OS.

A.3 Intel® Hyper-Threading Technology



- The motherboard supports Intel® Pentium® 4 LGA775 processors with Hyper-Threading Technology.
 - Hyper-Threading Technology is supported under Windows® XP/2003 Server and Linux 2.4.x (kernel) and later versions only. Under Linux, use the Hyper-Threading compiler to compile the code. If you are using any other operating systems, disable the Hyper-Threading Technology item in the BIOS to ensure system stability and performance.
 - Installing Windows® XP Service Pack 1 or later version is recommended.
 - Make sure to enable the Hyper-Threading Technology item in BIOS before installing a supported operating system.
 - For more information on Hyper-Threading Technology, visit www.intel.com/info/hyperthreading.
-

Using the Hyper-Threading Technology

To use the Hyper-Threading Technology:

1. Install an Intel® Pentium® 4 CPU that supports Hyper-Threading Technology.
2. Power up the system and enter the BIOS Setup. Under the **Advanced Menu**, make sure that the item **Hyper-Threading Technology** is set to **Enabled**. See page 4-26 for details.
The BIOS item appears only if you installed a CPU that supports Hyper-Threading Technology.
3. Restart the computer.

